

Brüel & Kjær



Technical Review

To Advance Techniques in Acoustical, Electrical, and Mechanical Measurement

NEW CONDENSER MICROPHONES

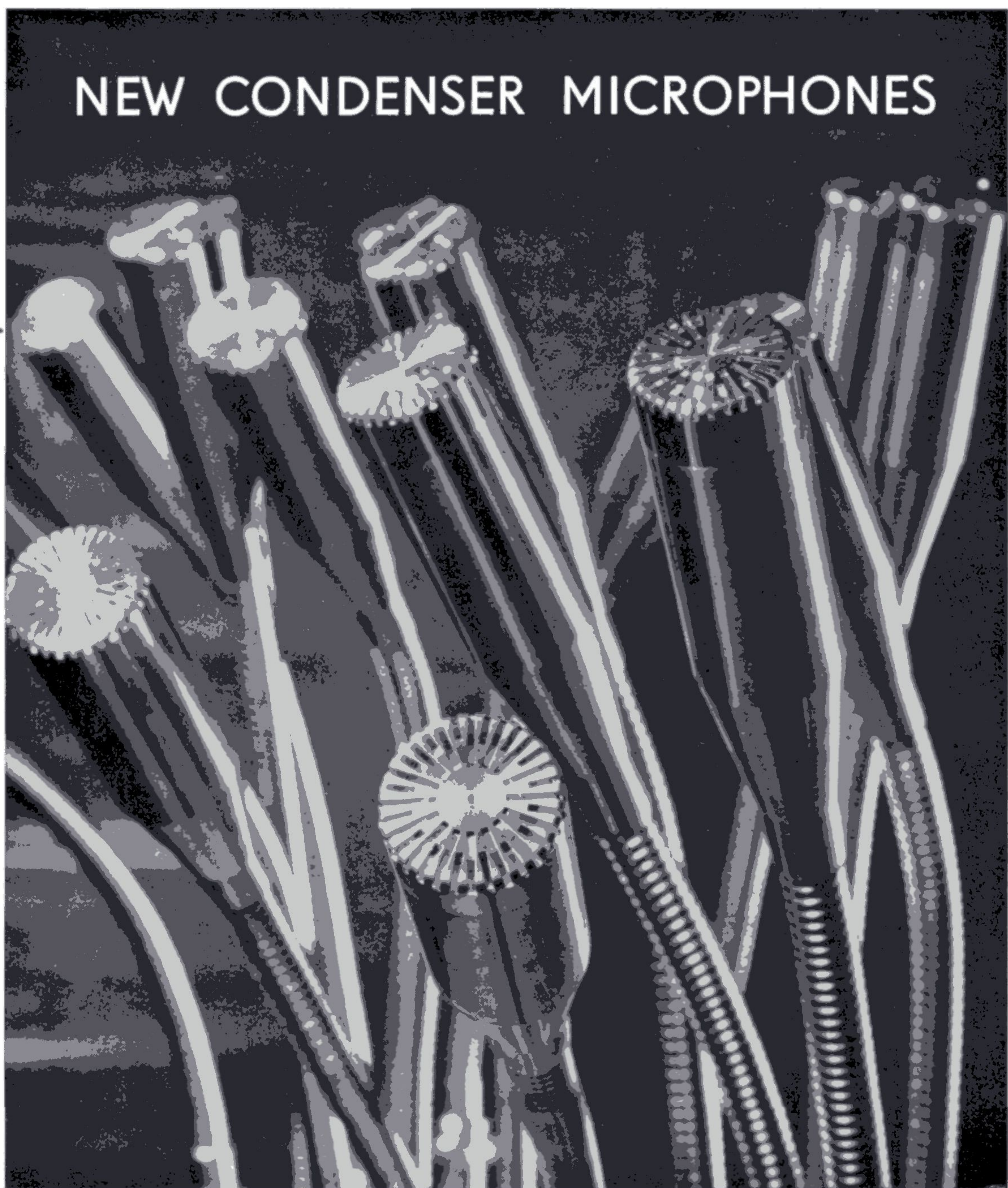

**PREVIOUSLY ISSUED NUMBERS OF
BRÜEL & KJÆR TECHNICAL REVIEW**

- 1-1954 Noise Measurements with the Audio Frequency Spectrometer Type 2109.
- 2-1954 The Automatic Analysis of Distortion in Sound Reproducing Equipment.
- 3-1954 Mobile Laboratories.
- 4-1954 Tube Measurements and Sound Insulation. Calibration of Probe-Tube Microphones.
- 1-1955 The Standing Wave Apparatus.
- 2-1955 Modern Accelerometers.
- 3-1955 Non Linearity of Condenser Microphones.
- 4-1955 A New Beat Frequency Oscillator Type 1014.
- 1-1956 Noise Measurements and Analyses.
- 2-1956 Use of Resistance Strain Gauges to determine Friction Coefficients.
- 3-1956 Determination of Acoustical Quality of Rooms from Reverberation Curves.
- 4-1956 Electrical Measurements of Mechanical Vibrations.
- 1-1957 Strain Gauge Measurements.
- 2-1957 Sound Analysis in Industrial Processes and Production.
- 3-1957 Measurement on Tape Recorders.
- 4-1957 Measurements of Modules of Elasticity and Loss Factor for Solid Materials.
Surface Roughness Measurements.
- 1-1958 Measurement of the Complex Modulus of Elasticity.
- 2-1958 Vibration Testing of Components.
Automatic Level Regulation of Vibration Exciters.
- 3-1958 Design Features in Microphone Amplifier Type 2603 and A. F. Spectrometer Type 2110.
A true RMS Instrument.
- 4-1958 Microphonics in Vacuum Tubes.

COPIES AVAILABLE ON REQUEST

TECHNICAL REVIEW

No. 1 - 1959

Reprint November 1962

Contents.

	Page
A New Condenser Microphone.....	3
Free Field Response of Condenser Microphones.....	12
News from the Factory.....	18

A New Condenser Microphone

by

Gunnar Rasmussen

SUMMARY

A brief description of the principle of operation of a condenser microphone is given with special regard to the design of the Condenser Microphone Type 4131 and 4132. The mechanical construction and the acoustical qualities of the Microphones are discussed and the most important features outlined.

ZUSAMMENFASSUNG

Es wird die Arbeitsweise eines Kondensatormikrophons unter besonderer Berücksichtigung der Mikrophone Type 4131 und 4132 sowie deren Konstruktion und Eigenschaften beschrieben.

RÉSUMÉ

Une brève description du principe de fonctionnement d'un microphone à condensateur est donnée, axée spécialement sur la conception des microphones à condensateur types 4131 et 4132. La construction mécanique et les qualités acoustiques de microphones sont traitées et l'on fait ressortir les caractéristiques les plus importantes.

Introduction.

In almost every electronic instrumentation used for the measurement of non-electrical quantities, the transducer is the weakest link. Consequently, the accuracy and reliability of the measurements mainly depend on the choice and the correct use of the transducer involved. This is specially true when speaking of the field of acoustic measurements, where the main transducers are microphones which are represented on the market by a wide variety of types. However, in the vast majority of cases, the condenser microphone is the type to be preferred, featuring high stability and flat frequency characteristic combined with reasonably high sensitivity.

The condenser microphone consists basically of a thin metal diaphragm and a back plate constituting the electrodes of a capacitor. Charging the capacitor by a DC voltage, the so-called polarization voltage, the variations in capacity caused by the sound impinging on the thin diaphragm, are transformed into voltage variations; a necessary condition being, however, that the charging time-constant of the circuit is big enough to keep the charge on the capacitor constant. This will always be the case above a certain lower limiting frequency. To increase the relative variation in capacity, and by this the sensitivity, the stray capacity of the condenser microphone and succeeding

amplifier input must be as small as possible. Therefore the microphone and the first amplifier stage are normally built in the same housing. The small capacity, furthermore, requires a high load impedance to ensure a low lower limiting frequency. So, the first amplifier stage is designed as a cathode follower, "transforming" the input impedance of a normal microphone amplifier into the high impedance necessary.

In the following a new Condenser Microphone is described. To avoid any mistake, the microphone is called a Microphone Cartridge, and the pre-amplifier a Cathode Follower. A complete microphone consists, consequently, of a Microphone Cartridge and a Cathode Follower as shown in Fig. 1.

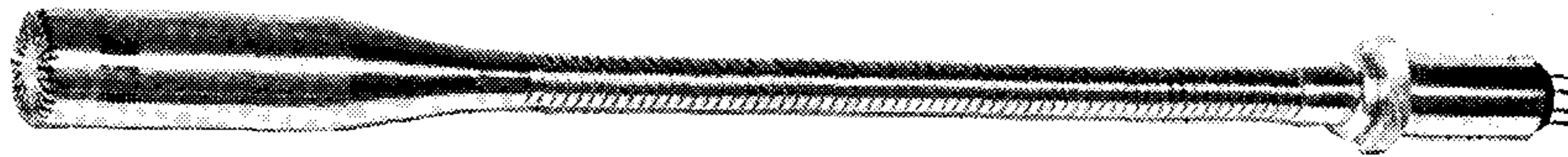

Fig. 1. Photo of the Condenser Microphone Cartridge Type 4132 and Cathode Follower Type 2612.

Construction of the Microphone Cartridge.

The Microphone Cartridge Type 4132 has primarily been designed to meet the requirements set in the American Standard Z 24.8-1949 for a Laboratory Standard Pressure Microphone type L. This means that the Microphone Cartridge is a precision measuring microphone, but may, of course, as well be used as a studio microphone. Furthermore, it was desired to make a microphone which is as mechanically and electrically stable as possible, and which can operate over a wide range of ambient temperature, pressure, and humidity conditions.

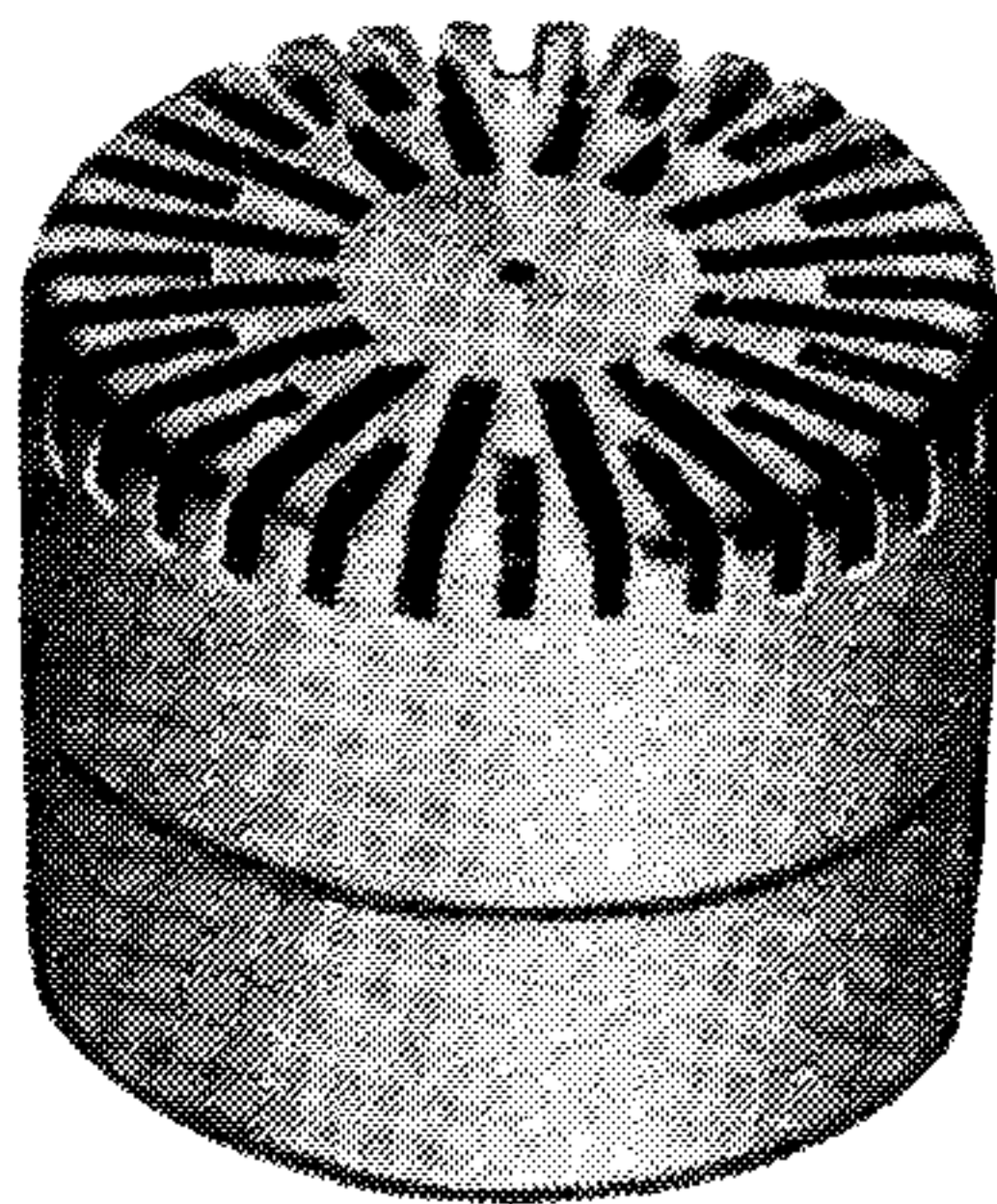

Fig. 2. Photo of the Condenser Microphone Cartridge Type 4132.

The problems to be solved are mainly of mechanical nature, being a question of choosing suitable materials and assembling the different parts in such a way that the influence of the environments are minimized. A description of the mechanical construction of the Microphone Cartridge will clearly show how this is obtained.

In Fig. 3 is shown a sectional view of the Condenser Microphone Cartridge Type 4132. As it appears from the figure, the cartridge consists basically of a microphone housing which carries the different parts, such as microphone

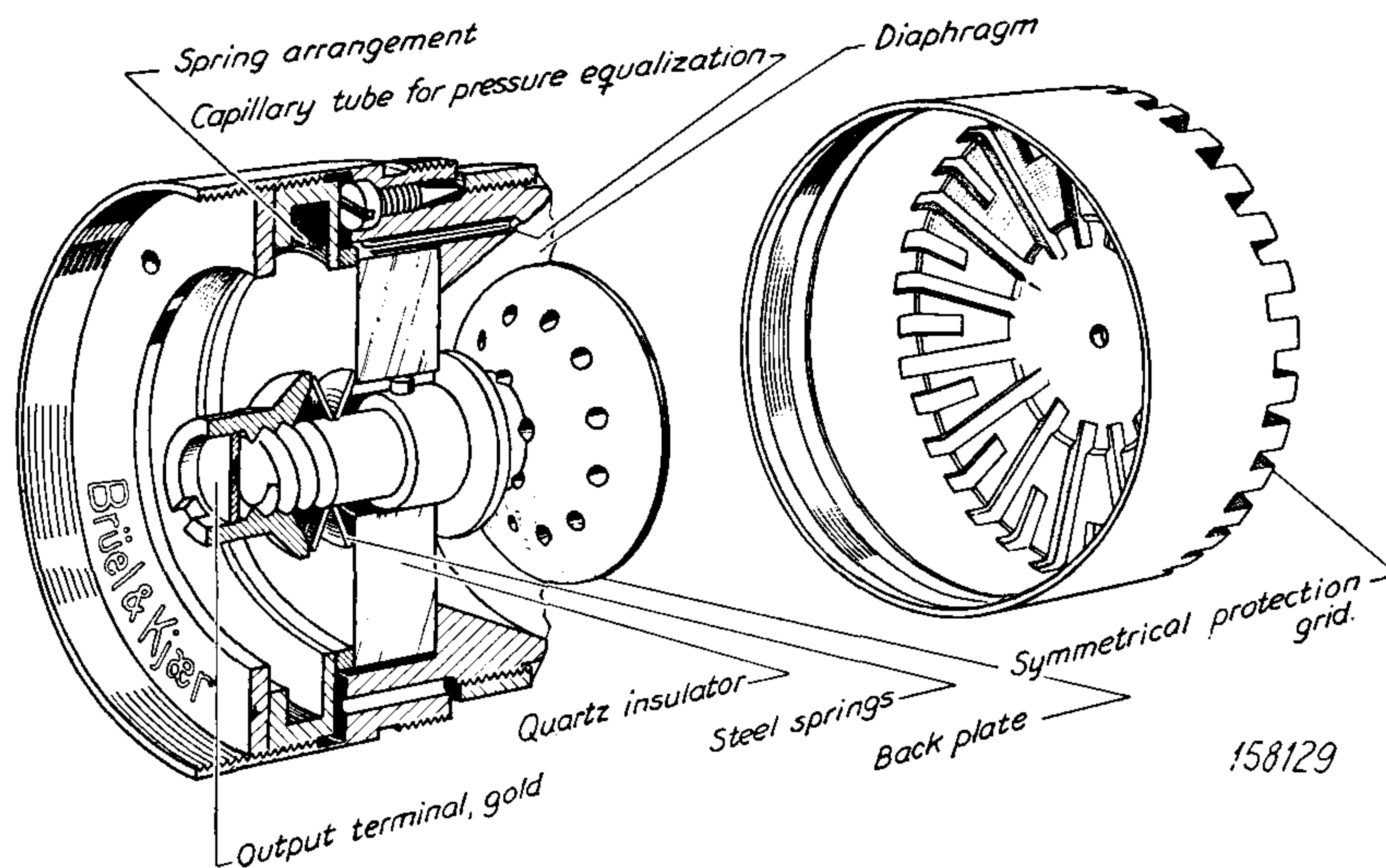

Fig. 3. Sectional view of the Condenser Microphone Cartridge Type 4132.

diaphragm, back plate, insulator, nuts etc. The housing, the diaphragm, and the back plate are made of nickel and high nickel alloys, the more secondary metal parts of nickel plated brass, and the insulator is made of quartz. To increase the moisture resistivity the quartz insulator is treated with silicone, and to ensure perfect electrical contact to the Cartridge, the contact surface of the output terminal is made of solid gold. The materials so selected ensure high corrosion resistance and strength under normal working conditions.

Since the sensitivity is very closely related to the distance between the diaphragm and the back plate, special measures must be taken to prevent this distance from changing. Being only about 20 μ metres (0.8 Mill) only small temperature variations make the distance change considerably if no precautions were made. As is seen from Fig. 3, the back plate is fixed on the quartz insulator between a collar and a spring loaded nut. This arrangement ensures a constant distance between the frontside of the back plate and the front side of the insulator (for constant temperature). Correspondingly, a constant distance from the front side of the insulator to the front of the microphone housing is ensured by recessing the insulator in the housing and fixing it by means of a threaded ring. With the diaphragm screwed on the end of the housing and stretched over the edge, the distance from the back plate to the diaphragm is determined by the difference between the two constant distances mentioned above. The thermal expansion of this distance being only approx. $20 \cdot 10^{-6} \times 13.9 \cdot 10^{-6}$ m per C° for a constant diaphragm tension. See Fig. 4 for a typical sensitivity versus temperature curve. Furthermore, the arrangement used makes the diaphragm tension independent of the

contact pressure, and the steel springs used for clamping the back plate will allow a contact pressure of more than 1 kg (2.2 lbs.).

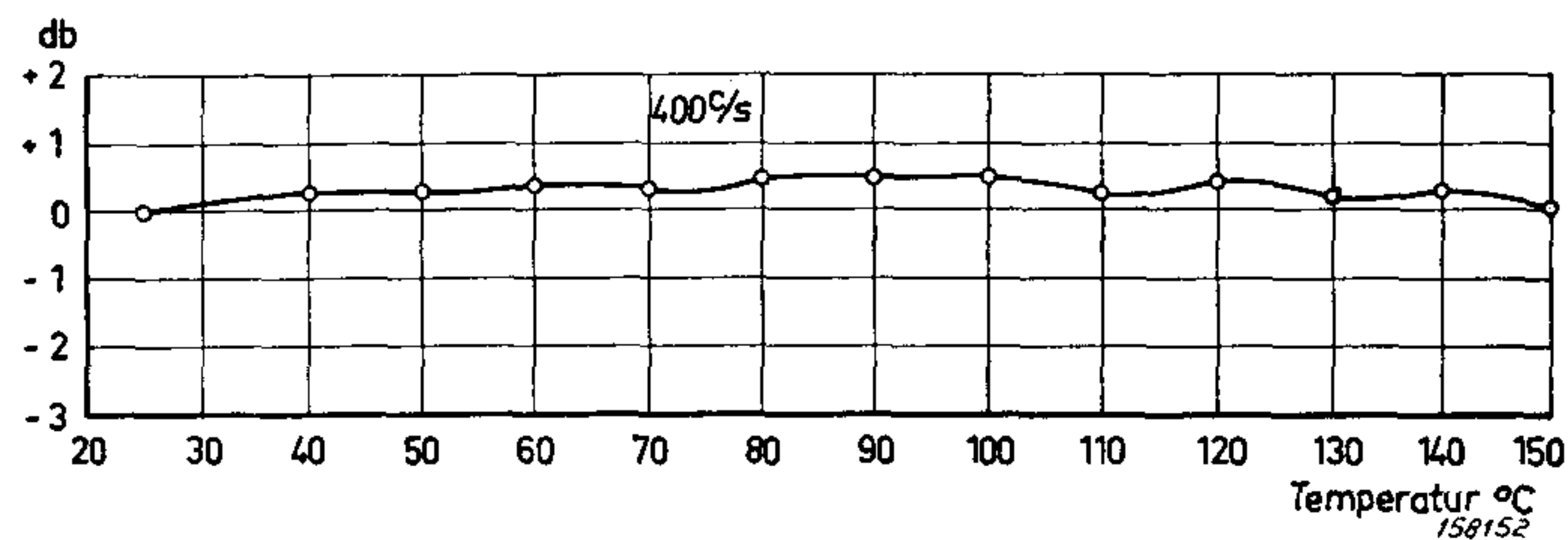

Fig. 4. Typical curve showing the sensitivity versus temperature for the Microphone Cartridges.

Not only the temperature, but also the ambient pressure may affect the sensitivity of the microphone. If the pressure in front of the microphone increases (or decreases), the distance between the diaphragm and the back plate will change, because the diaphragm deflects. If the pressure variations are within the frequency range in which the microphone should be used for acoustic measurements, the pressure variations should only take place on one side of the diaphragm, and the Cartridge consequently be tight. If, however, the variations are slower (f. inst. changes in the static pressure), a pressure equalization on both sides of the diaphragm should take place to avoid erroneous measurements. This equalization is established through a capillary tube which connects the cavity behind the diaphragm with the open air. The capillary tube, however, does not connect the inside of the Cartridge directly with the open air, but is designed as a dusttrap. From the back of the diaphragm the tube leads to the spacing between the insulator and the treaded ring. Displaced from this entry another tube connects the spacing with the open air at a point between the diaphragm suspension ring and the housing. This arrangement makes it also possible to use the Cartridge mounted in a wall separating two rooms with different static pressures. The equalization system described, furthermore, keeps the Microphone Cartridge free from condensed moisture. When the Cartridge breathes the cooler air outside the Microphone into the relative more hot cartridge back room no condensation can take place. The often very troublesome noise problems due to moisture condensation in microphone types breathing the hot air from the cathode follower into the relative cooler cartridge, are in this way eliminated. Furthermore, the air relief entrance is made at the place which should be least critical, the most critical parts being the insulator surface and the spacing between the back plate and the diaphragm. It might appear not to be worth while to offer that much concern on a small thing like this. However, the air relief arrangement and the condensed moisture have been the occasion of the major problems concerning the use of the condenser microphone cartridges hitherto made.

To protect the diaphragm against mechanical overload the Cartridge is supplied with a protecting grid. For special measurements the grid may be

screwed off the Cartridge, which is then easily mounted in acoustical couplers, shieldings, and in special set-ups. The outer thread on the Cartridge is the same as the inside thread used for mounting the Cartridge on the Cathode Follower, namely 0.910"-60-NS2, as shown in the American Standard for Pressure Calibration of Laboratory Standard Pressure Microphones Z 24.4-1949 — Fig. 6.

The Acoustical Properties of the Condenser Microphones.

The Condenser Microphone Cartridges are made in two different versions, which viewed from the outside are completely alike, but acoustically different. One of them, Type 4131, features a free field response characteristic which is linear to within ± 2 db up to approx. 18 kc/s for perpendicular incidence and with the protective grid mounted, (Fig. 5). The other one, Type 4132, has

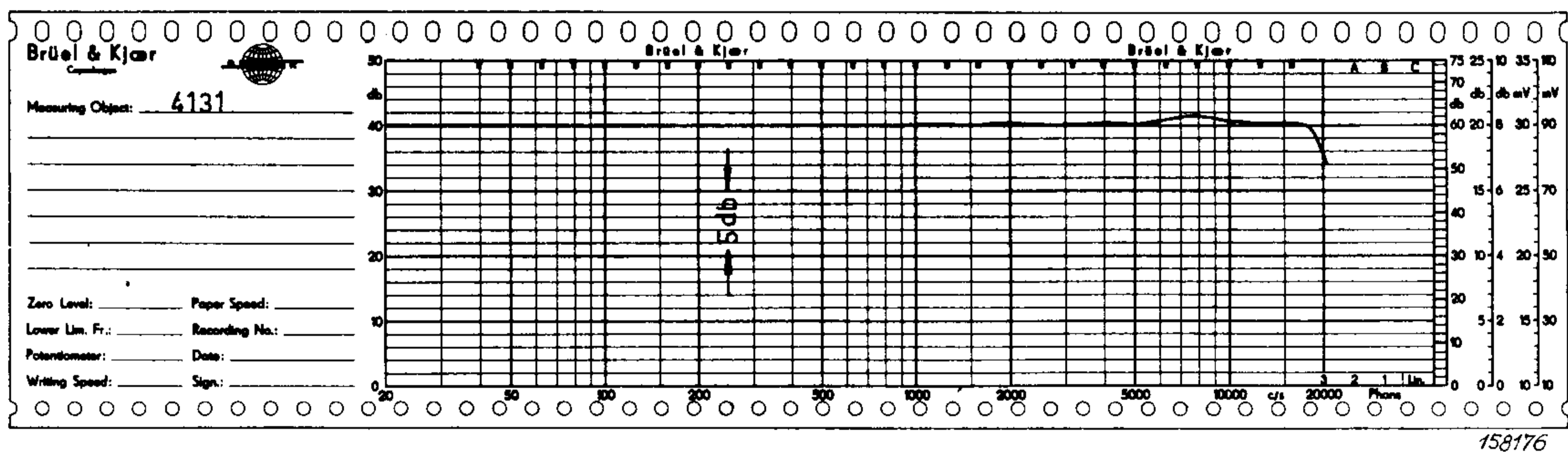

Fig. 5. Typical free field frequency response characteristic of the Condenser Microphone Cartridge Type 4131 and Cathode Follower Type 2612 (or 2613) for perpendicular incidence.

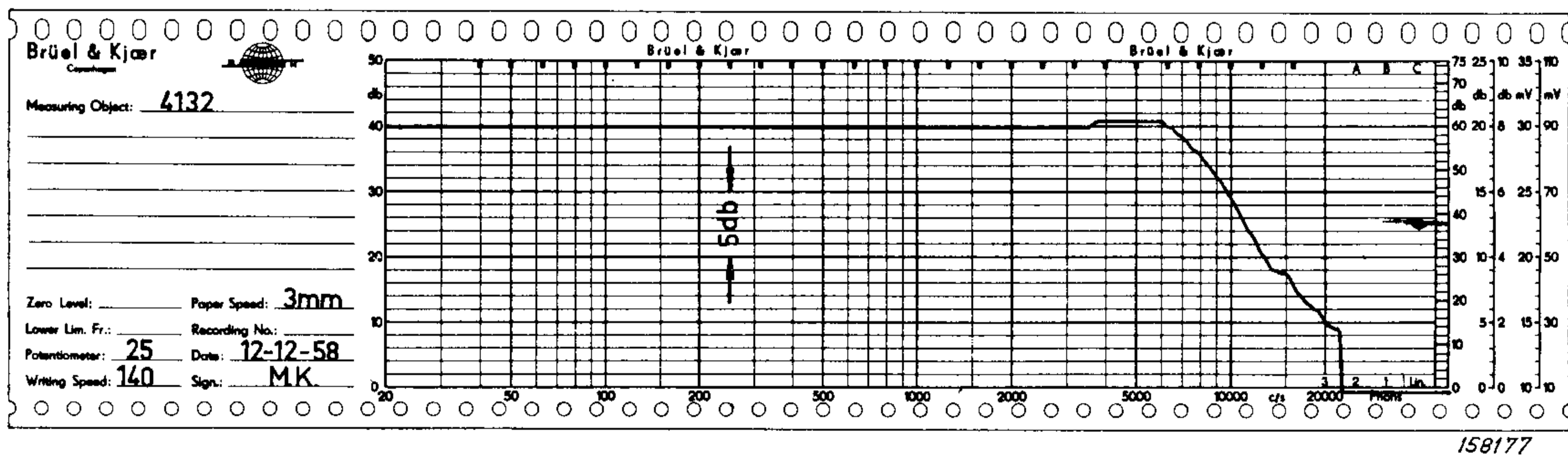

Fig. 6. Typical pressure response characteristic of the Condenser Microphone Cartridge Type 4132 and Cathode Follower Type 2612 (or 2613).

a pressure response characteristic which covers the frequency range up to 7 kc/s as required in the American Standard Z 24.8, see Fig. 6. Both types of Microphones have a sensitivity of 3.5—5.5 mV/ μ bar (or — 49 db to — 45 db re 1 Volt/ μ bar) when used with a polarization voltage of 200 Volts. The data

specified presume that the Cartridges are used in connection with one of the Cathode Followers Type 2612 or 2613. See Fig. 4.

If another polarization voltage than 200 Volts is used, the sensitivity of the microphone cartridges is changed. From the equation $e = E_0 \frac{X}{X_0} \sin \omega t$ *) is seen that the output voltage is directly proportional to the polarization voltage E_0 and inversely proportional to the distance X_0 between the diaphragm and the back electrode: the diaphragm variation being $X \sin \omega t$.

When the polarization voltage is changed, the electrostatic attraction between the diaphragm and the back plate and thus the distance X_0 will change. The change in sensitivity will therefore be greater than the relative change in polarization voltage as shown in Fig. 7.

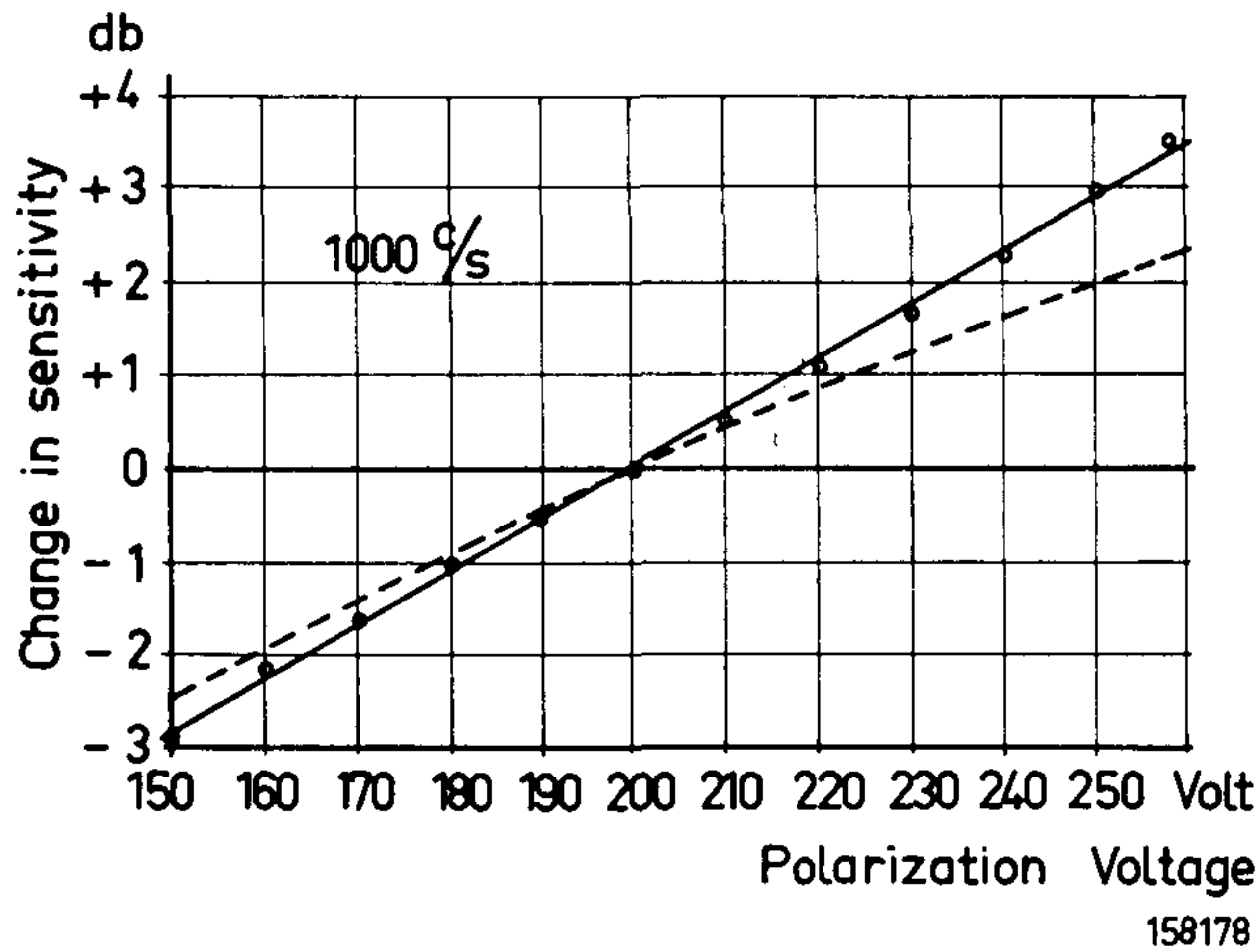

Fig. 7. Sensitivity versus polarization voltage for the Microphone Cartridges Type 4131 and 4132 drawn in full. Dotted line shows the variation in sensitivity calculated without taking the change in electrostatic attraction into account.

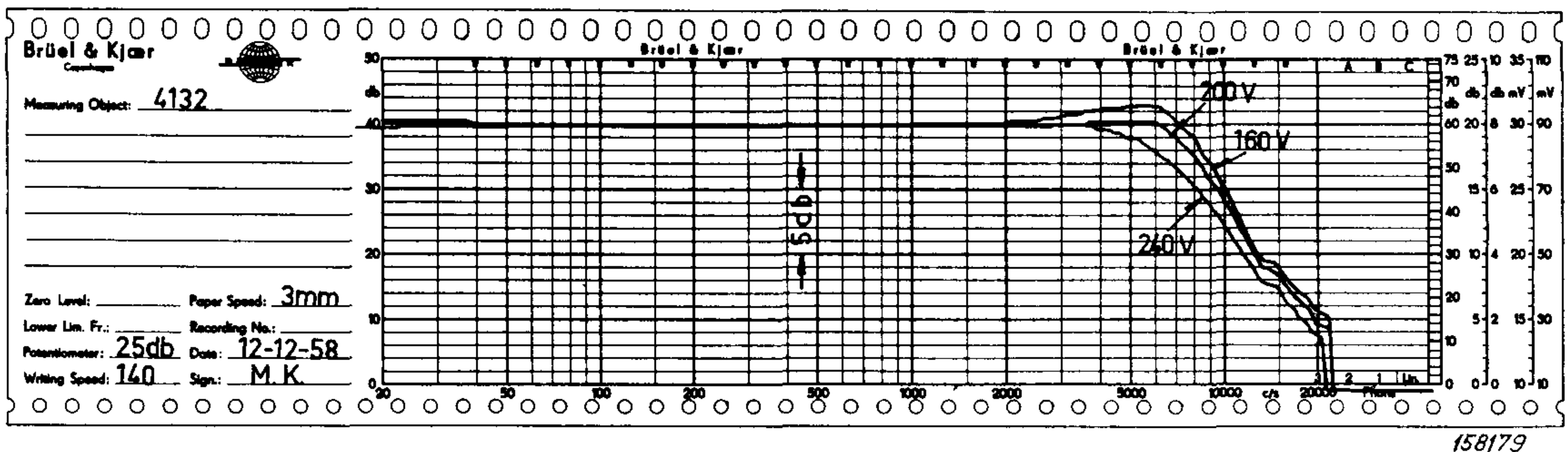

Fig. 8. Typical difference in pressure characteristic of a Condenser Microphone Cartridge Type 4132 measured with three different polarization voltages. Recorder adjusted to same deflection at 1000 c/s.

*) Willem Brand: Brüel & Kjær, Technical Review nr. 3 p. 3. July 1955.

As mentioned, the distance between the diaphragm and the back plate is a function of the polarization voltage. Since this distance is one of the main factors determining the mechanical damping on the diaphragm, a change will influence the frequency characteristic especially in the higher frequency end. In Fig. 8 is shown the pressure characteristic of the Microphone Cartridge Type 4132 measured for three different values of the polarization voltage. Another quality which depends on the stiffness of the diaphragm and the air cushion behind the diaphragm is the equivalent air volume of the Cartridge. It is specially important to know this volume when measurements are carried out in acoustic couplers, because the coupler volume is increased by this amount. The equivalent air volume is measured by means of the set-up shown

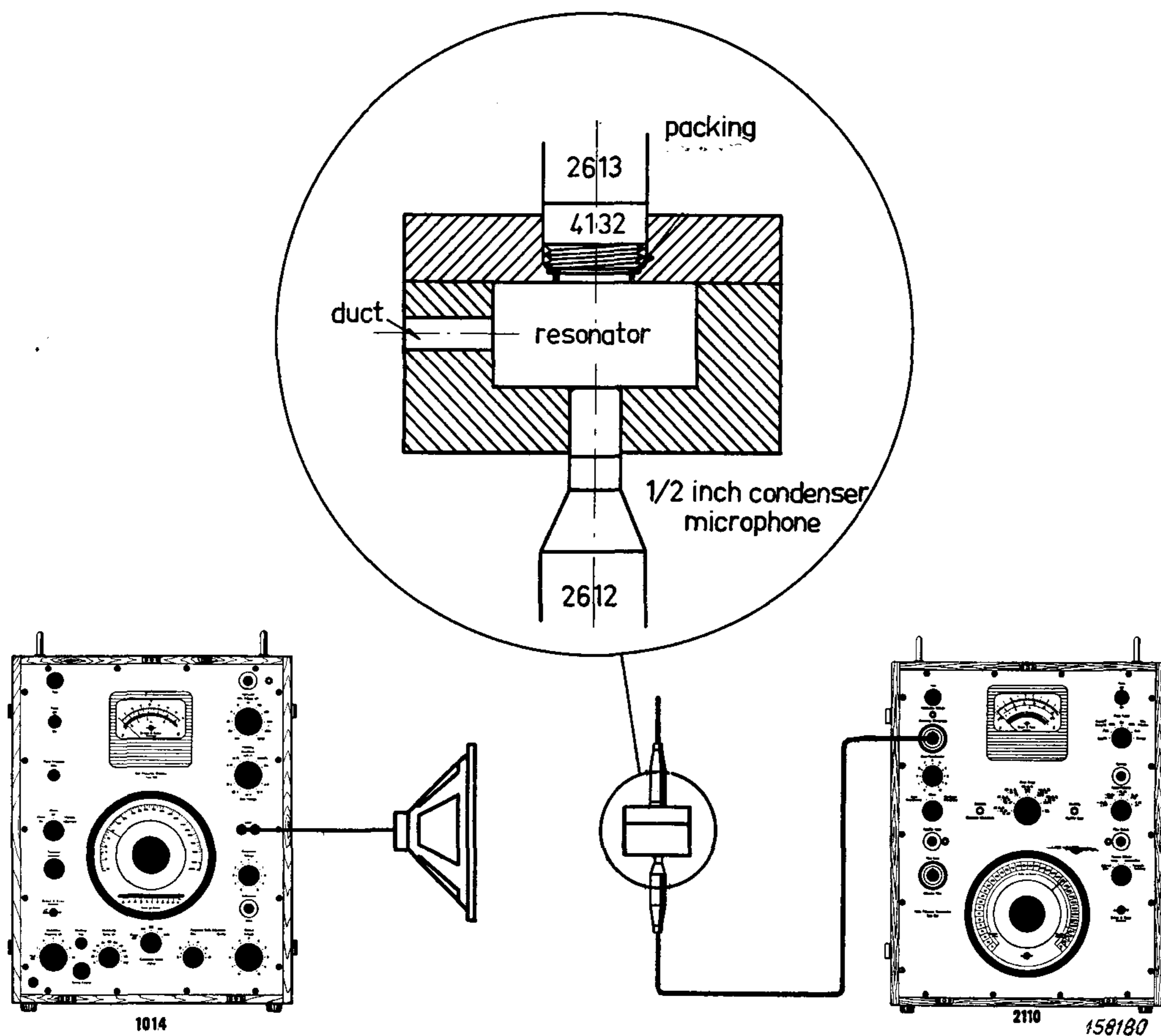

Fig. 9. Measuring arrangement for measurement of the equivalent air volume of a Condenser Microphone Cartridge.

in Fig. 9. The arrangement shown consists basically of a Helmholtz resonator with hard walls. The measurement is then carried out by measuring, in the first place, the resonance frequency of the resonator with the Condenser Microphone Cartridge Type 4132 replaced by a solid stopper, and then

measure the resonance frequency with the Cartridge inserted.)* From these two measurements it is easy to determine the correction to the cavity volume caused by the equivalent volume of the Cartridge. With the cavity volume V identifying an equivalent capacitor C ($C = \text{const.} \cdot V$), and the duct identifying an equivalent inductance L , the resonance frequency may be written:

$$f = \frac{1}{2\pi} \frac{1}{\sqrt{LC}}$$

The resonance frequency measured when the Microphone Cartridge is introduced, is increased by an amount Δf corresponding to a volume increase of ΔV . We may consequently write:

$$\frac{f}{f + \Delta f} = \sqrt{\frac{C + \Delta C}{C}} = \sqrt{\frac{V + \Delta V}{V}}$$

$$\Delta V \sim -2 \cdot V \cdot \frac{\Delta f}{f}$$

By adjusting the cavity to have a resonance frequency of $f = 1000$ c/s, and a basic volume of $V = 2$ cm³, is found that

$$\Delta V = \underline{-4 \cdot 10^{-3} \cdot \Delta f \text{ cm}^3}$$

The sound field is set up by a loudspeaker fed from the BFO (Type 1014). By using the incremental frequency scale of the BFO, the frequency increase Δf is very accurately measured. The sound pressure level inside the cavity is measured by means of a built-in 1/2" condenser microphone. The only demand which must be made on this microphone is that the diaphragm must act as a rigid wall, in order to obtain a reasonable Q-value of the resonator. This is important because the accuracy of the measurement depends on the accuracy of the determination of the resonance frequency. The equivalent volume of the Cartridges Type 4132 is in this way found to be about 0.1—0.2 cc.

When used for measurements in acoustic couplers, the *only* correction to be added to the coupler volume is the equivalent volume of the Cartridges. This is obtained by designing the front of the Cartridge without the cavity found in many conventional microphones (see Fig. 10). The main advantages derived from the flat, cylindrically shaped front are, however, that relatively simple mathematics can be used to determine the reflections and disturbances which the microphone causes in a sound field, and that the sound waves travelling parallel to the diaphragm may impinge on it directly. The flat front, furthermore, makes the difference between the free field response and the pressure response of the Cartridge the smallest possible, for an actual mechanical size. This is seen in Fig. 10.

*) The method was reported by T. F. W. Embleton and I. R. Dagg, National Research Council, Ottawa, Ontario on the ASA meeting held in Washington DC in May 1958.

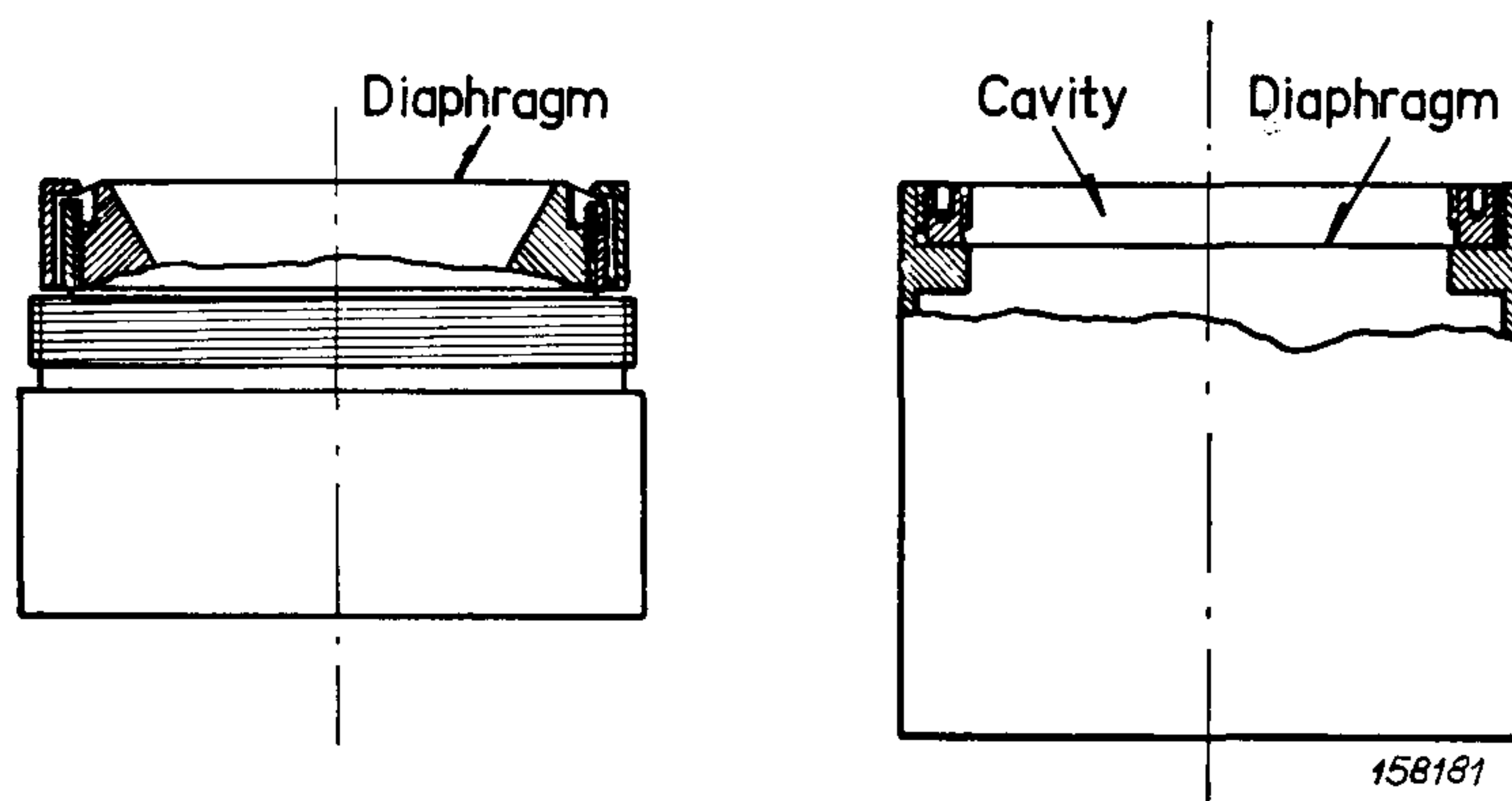

Fig. 10. Sectional view of Microphone Cartridge Type 4131 and a conventional microphone cartridge with cavity in front of the diaphragm.

Finally should be mentioned that when the Condenser Microphone Cartridges Type 4131 and Type 4132 leave the factory, they are supplied with the following specifications:

- 1) an individually measured frequency response characteristic from 20 c/s to 20000 c/s (for 4131 both the frequency response for 0° incidence and the pressure response characteristic),
- 2) individually measured sensitivity, and
- 3) an individually measured polarized capacity (for Type 4132 also individually measured equivalent volume).

Free Field Response of Condenser Microphones

by

Per V. Brüel and Gunnar Rasmussen

SUMMARY

The difference between free field response and pressure response characteristics of condenser microphones is determined by two different methods:

- A. By measuring the pressure distribution around a model of the microphone placed in a free sound field, as well as the sensitivity distribution over the microphone diaphragm. From these measurements, and by means of a specially designed concentric electrostatic actuator the effective sound pressure increase on the diaphragm is calculated.
- B. By measuring the microphone sensitivity as a function of frequency according to the free field reciprocity method, and comparing the results with the pressure response of the same microphones measured by means of the electrostatic actuator method.

The pressure increase curves obtained according to the two different methods A) and B) showed excellent agreement for the Condenser Microphones Type 4131 and 4132 used for the experiments.

ZUSAMMENFASSUNG

Es werden zwei Verfahren für die Bestimmung der Druckanstiegskurve von Kondensatormikrofonen angegeben:

- A. Man untersucht die Druckverteilung an einem Modell des Mikrophons im freien Feld sowie die Empfindlichkeitsverteilung über der Membran. Auf der Grundlage dieser Untersuchungen erhält man die Druckanstiegskurve mit Hilfe eines speziell entwickelten Eichgitters.
- B. Die Frequenzkurve wird punktweise nach der Freifeld-Reziprozitätsmethode gemessen und mit der nach der elektrostatischen Methode gemessenen Druckkammerkurve verglichen.

Die nach den beiden Verfahren A) und B) berechneten Druckanstiegskurven der Kondensatormikrophone Typ 4131 und 4132 stimmen vollkommen überein.

RÉSUMÉ

La différence entre les caractéristiques de réponse en champ libre et à la pression des microphones à condensateur est déterminée par 2 méthodes différentes:

- A. En mesurant la distribution de la pression autour d'un modèle du microphone placé en champ libre, ainsi que la répartition de la sensibilité sur le diaphragme du microphone. Du résultat de ces mesures ainsi que de l'emploi d'un excitateur électro-acoustique concentrique spécialement étudié, on calcule l'augmentation effective de la pression sonore sur le diaphragme.
- B. En mesurant la sensibilité du microphone en fonction de la fréquence selon la méthode de réciprocité en champ libre et en comparant les résultats avec la réponse à la pression des mêmes microphones, mesurée par la méthode de l'excitateur électroacoustique.

Les courbes d'augmentation de la pression obtenues selon les deux méthodes différentes A et B sont en excellent accord pour les microphones à condensateur 4131 et 4132 utilisés pour les expériences.

In connection with the development work on the new Condenser Microphones Type 4131 and 4132 it was of importance to investigate very thoroughly the reflecting properties of the microphones when placed in a free sound field, and compare the free-field response with the pressure response as measured by means of for example an electrostatic actuator.

Most condenser microphones are calibrated according to measuring methods which give the pressure response only, i.e. the relationship between the output voltage and the average sound pressure on the microphone diaphragm. This sensitivity is normally expressed in $\text{mV}/\mu\text{bar} = \text{mV}/\text{dyn cm}^{-2}$, or db re.

1 volt/ μ bar. The sensitivity depends upon the frequency and is therefore given in the form of a curve plotted as a function of frequency—the pressure response frequency curve. Measuring methods suitable for the determination of pressure response are:

1. Electrostatic Actuator (1, 2)*), e.g. UA 4113 or the new UA 0023, which mainly consists of an electrically isolated grid, placed immediately in front of the microphone diaphragm. A polarization voltage (800 volts) and an AC voltage (10 to 50 volts) are supplied to the actuator causing an alternating electrostatic force between the grid and the microphone diaphragm simulating a sound pressure equally distributed across the diaphragm.

This method is not very suitable for absolute calibration of microphones because the electrostatic force and the corresponding pressure on the diaphragm depend on the distance between the grid and the diaphragm with its squared value. The method is, on the other hand, very well suited for the measurements of pressure response frequency characteristics.

2. Reciprocity method (3, 4) by means of acoustic couplers in connection with for example the Microphone Calibration Apparatus Type 4119 or 4141.

This method is used in nearly all standard laboratories and is at present known to be the most accurate calibration method. The sound pressure is the same at all points inside the acoustic coupler, whereby an equal pressure distribution is obtained at the microphone diaphragm.

However, the method is not suited for measurements at high frequencies where the sound pressure is no longer the same at every point in the coupler, due to wave motion.

3. The pistonphone (7, 8) consists of a mechanically or electro-dynamically driven piston which, in a closed chamber, produces equal sound pressure at every point.

The measurement of the pressure response of a condenser microphone is thus relatively simple and the question is now which output voltage is obtained if a microphone with a known pressure response is placed in a sound field.

If a microphone is placed in a plane sound field with a pressure p_0 the sound wave will be partly reflected from the microphone and thus cause an increase in the effective sound pressure at the microphone diaphragm. The magnitude of this increase depends upon the wave length of the sound and the mechanical dimensions of the microphone front, as well as the angle between the direction of travel of the wave and the diaphragm. In Fig. 1 the particle movements at the microphone front are illustrated for the case that the direction of the sound wave is perpendicular to the microphone diaphragm (0° incidence). (In the following 0° incidence is assumed if not otherwise specified.) Because the main object is to measure the sound pressure which existed at a certain point in a sound field before the microphone was placed

*) Bibliography see p. 24.

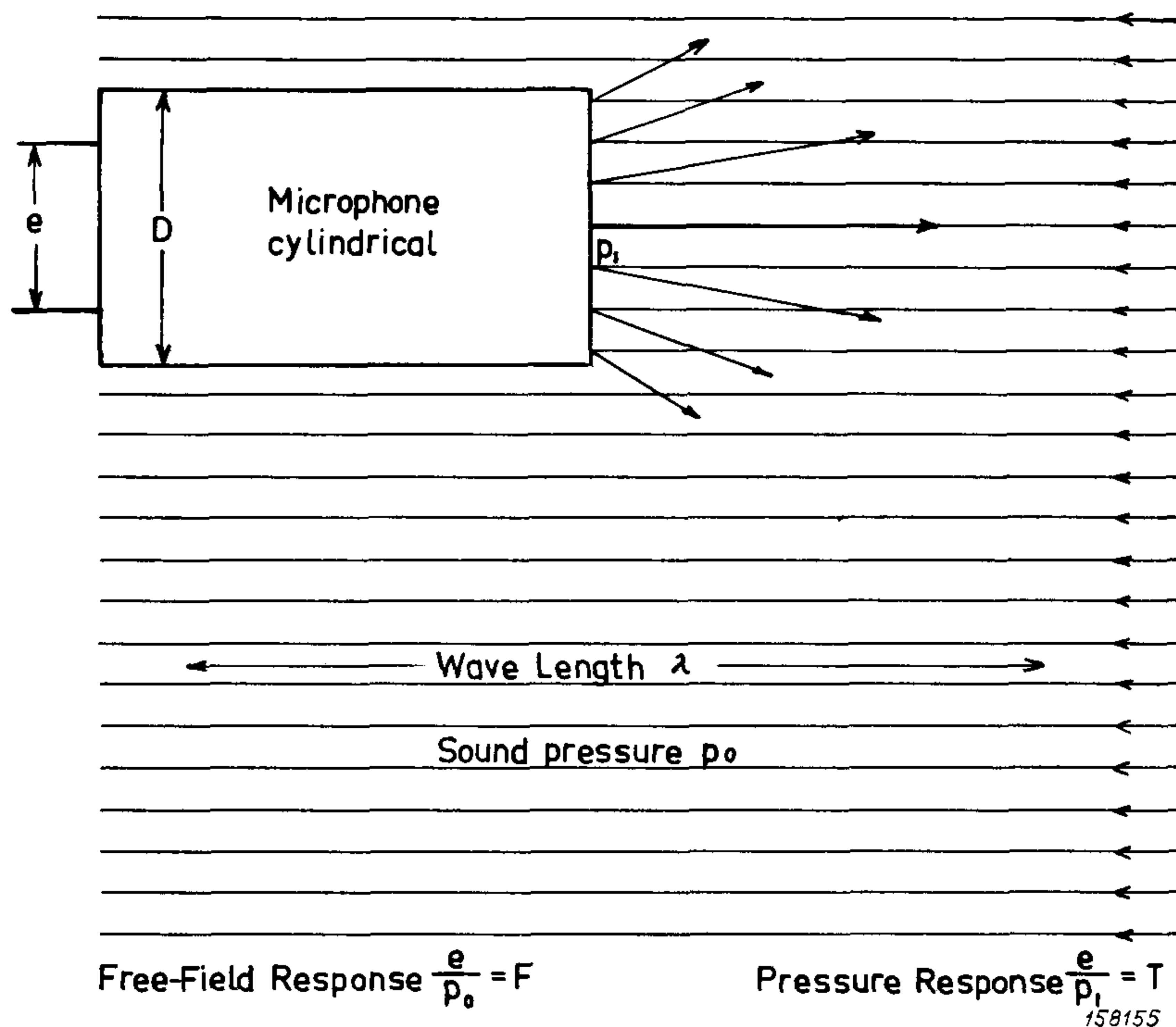

Fig. 1. Sketch showing the reflection from a cylindrically shaped microphone in a free sound field. The definition of pressure and free-field response is also given.

at this point, the so-called free-field response is defined as the relationship between the output voltage and the "undisturbed" sound pressure. This free-field response shall therefore include the pressure increase at the microphone diaphragm, or in other words the free-field response is equal to the pressure response plus the pressure increase caused by reflections. When the pressure response curve is known the problem of finding the free-field response curve

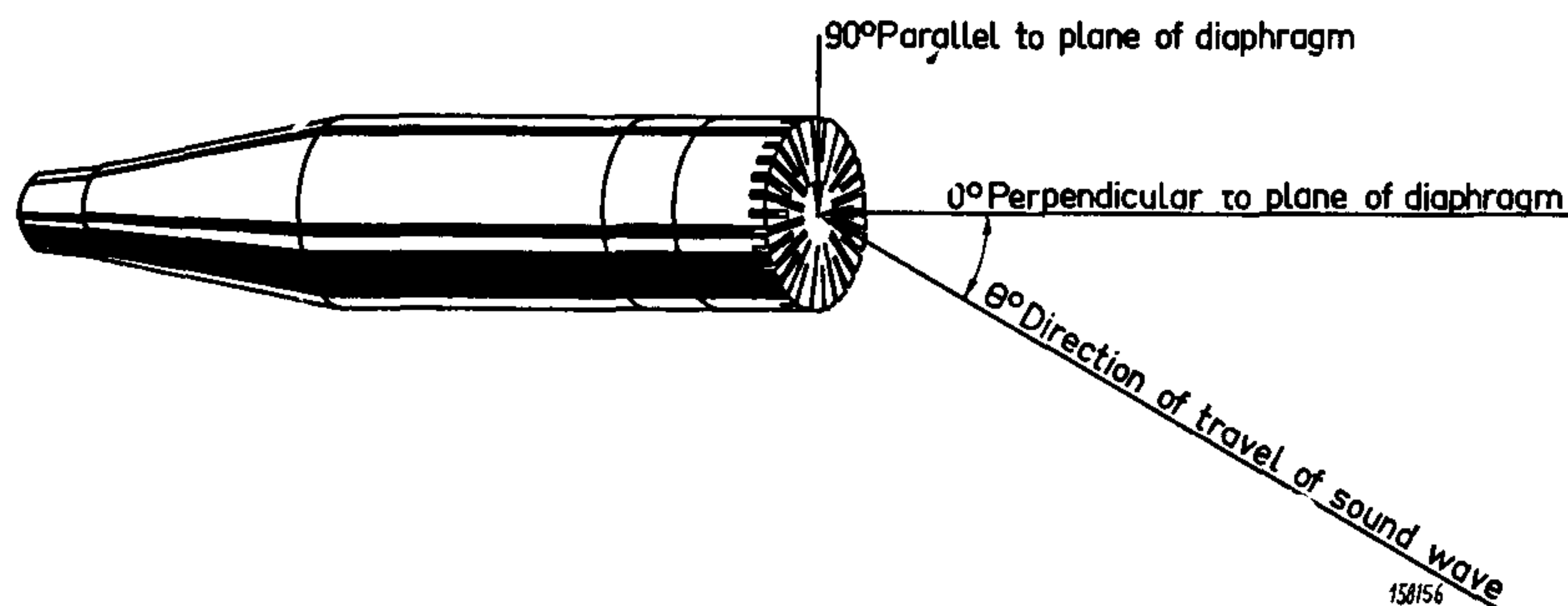

Fig. 2. Definition of the angles of incidence used throughout the article.

is reduced to that of finding the pressure increase correction curve, which is dependent upon the shape and physical dimensions of the microphone as well as the sensitivity distribution on the diaphragm. It is therefore necessary for a certain type of microphone to determine the pressure increase correction curve which then can be added to the individually measured pressure response

curve of the microphones. If the mechanical dimensions of the microphone are small the pressure increase will only be of importance at high frequencies and because it is always convenient to have as small a pressure increase as possible the mechanical dimensions should also be small. However, a limit is rather quickly reached with respect to the physical dimensions of the condenser microphone because small dimensions also result in a smaller sensitivity and very often also poorer stability. When the wave length of the sound is very small compared with the microphone dimensions, i.e. at very high frequencies, the sound waves for 0° incidence will be reflected as if they were impinging on an infinite wall. A pressure increase of 6 db is then obtained. For 90° incidence the microphone output voltage will at high frequencies approach 0.

In the range between very low frequencies, where the pressure increase is 0 and the very high frequencies, where the pressure increase is 6 db, a very varying frequency response is obtained, depending upon the different resonances at the microphone surface. To theoretically calculate the pressure increase it is necessary to use simple geometric microphone shapes as f. inst. a cylinder or spherical form. In practice a cylindrically shaped microphone where the diaphragm and the mounting edge are plane is very convenient and the pressure increase at the centre of the circular area is treated both mathematically and practically in the acoustical literature (9, 10). A mathematical treatment on this subject has been made by Müller, Black, and Davis who have also verified the theoretical results by means of practical measurements. In Fig. 3 the curve drawn in full indicates the results of the theoretical work

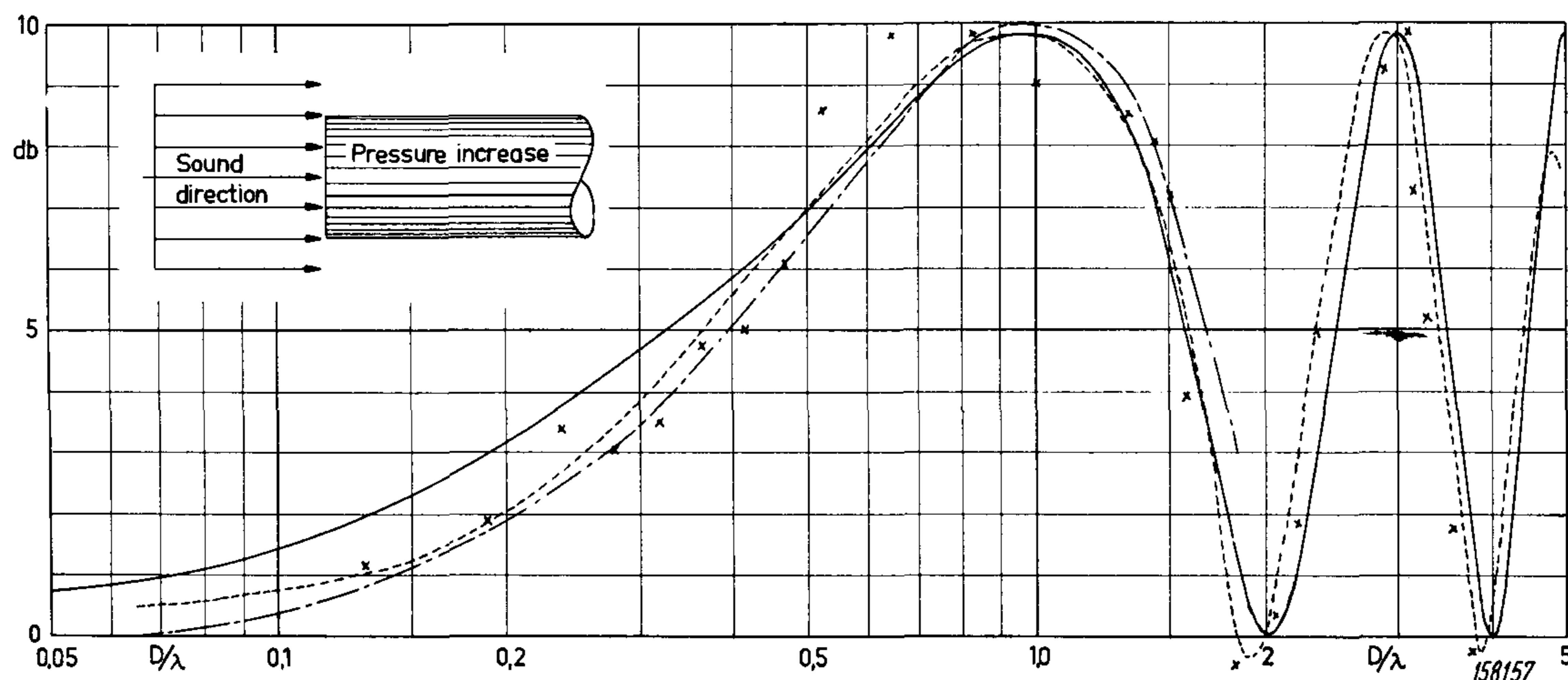

Fig. 3. Pressure increase at the axis of a cylinder the cylinder being placed in a free sound field. Curve drawn in full shows the theoretically calculated curve.

- xxxxx Measured by Müller, Black, and Davis (1937)
- · — · — Measured by Danish Technical University (1948)
- - - - - Measured by Brüel & Kjær (1958)

carried out by Müller, Black, and Davis and the points marked x correspond to their measurements. As abscissa is used the ratio $\frac{D}{\lambda}$ between the cylinder diameter and the wave length. The pressure increase is given in db relative to the sound pressure existing before the cylinder was placed in the sound field. It can be seen that the measured results do not coincide too accurately with the theoretical curve, a.o. a tendency exists to displace the frequency at which max. pressure increase is obtained downwards from the theoretical value $\frac{D}{\lambda} = 1$. In connection with the developments of our previous microphone Type 4111 measurements of pressure increase curves for cylinders have been carried out at the Danish Technical University the results being given as the dashed line in Fig. 3. This curve is in good agreement with the experimental results obtained by Müller, Black, and Davis but differs from the theoretical curve.

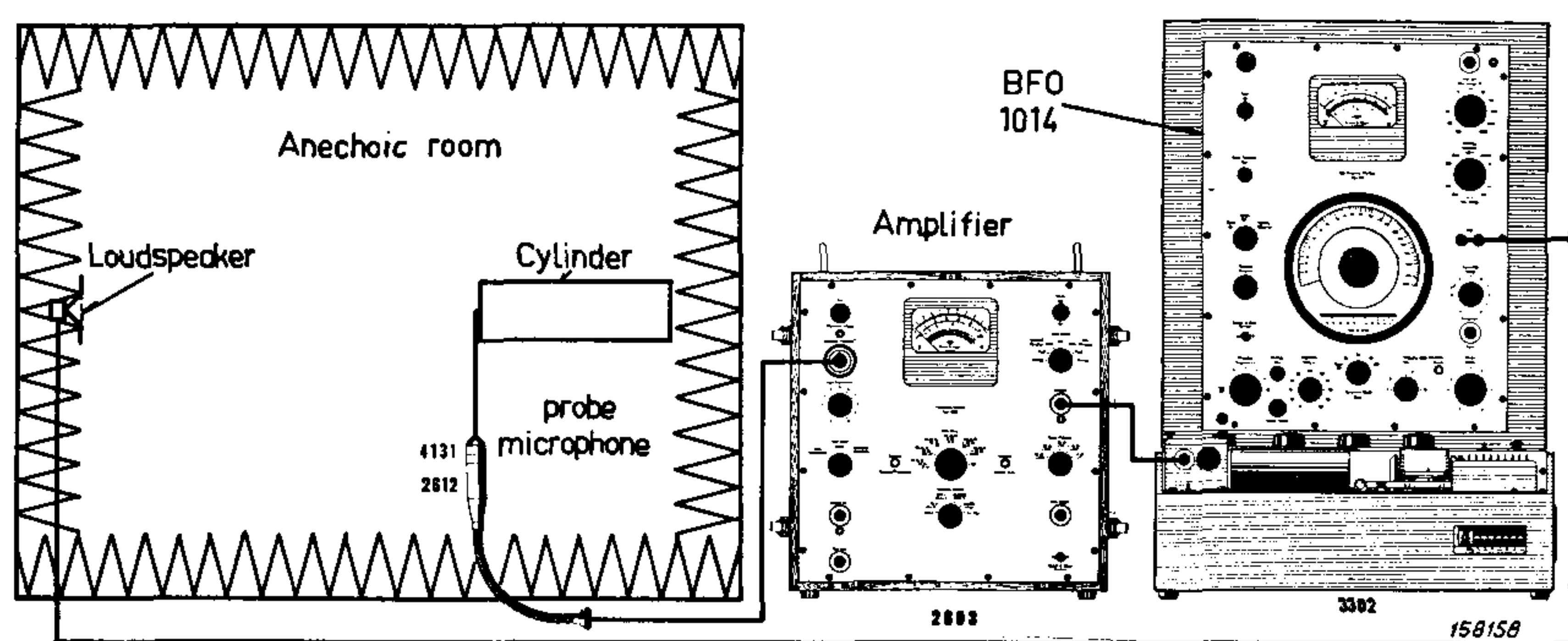

Fig. 4. Set-up used to measure the pressure increase at the axis of a cylinder.

To further investigate the phenomenon a number of measurements on a cylinder has been made by means of the measuring arrangement shown in Fig. 4. The cylinder is placed just behind the small probe tube microphone. The frequency characteristic of the loud-speaker and microphone is very accurately recorded both with and without the cylinder placed in the sound field. In Fig. 5 the measured results are shown and the difference between the two curves immediately gives the pressure increase at the centre of the cylinder. The high accuracy is obtained by using a 10 db potentiometer on the Level Recorder and extending the frequency scale. In this way the frequency curves can be recorded one after the other with the very accurate attenuator of the microphone amplifier adjusted to different values. A set of curves is thus obtained which can be combined as shown in Fig. 5. The results of the measurements are also shown in Fig. 3 (dotted line) and the very good agreement between this curve and the experimental results of Müller, Black, and Davis is clearly seen.

However, it is not sufficient to know the pressure increase at the centre of the cylinder because it is the average pressure across the diaphragm which is of interest with regard to the effective pressure increase. To find the pressure

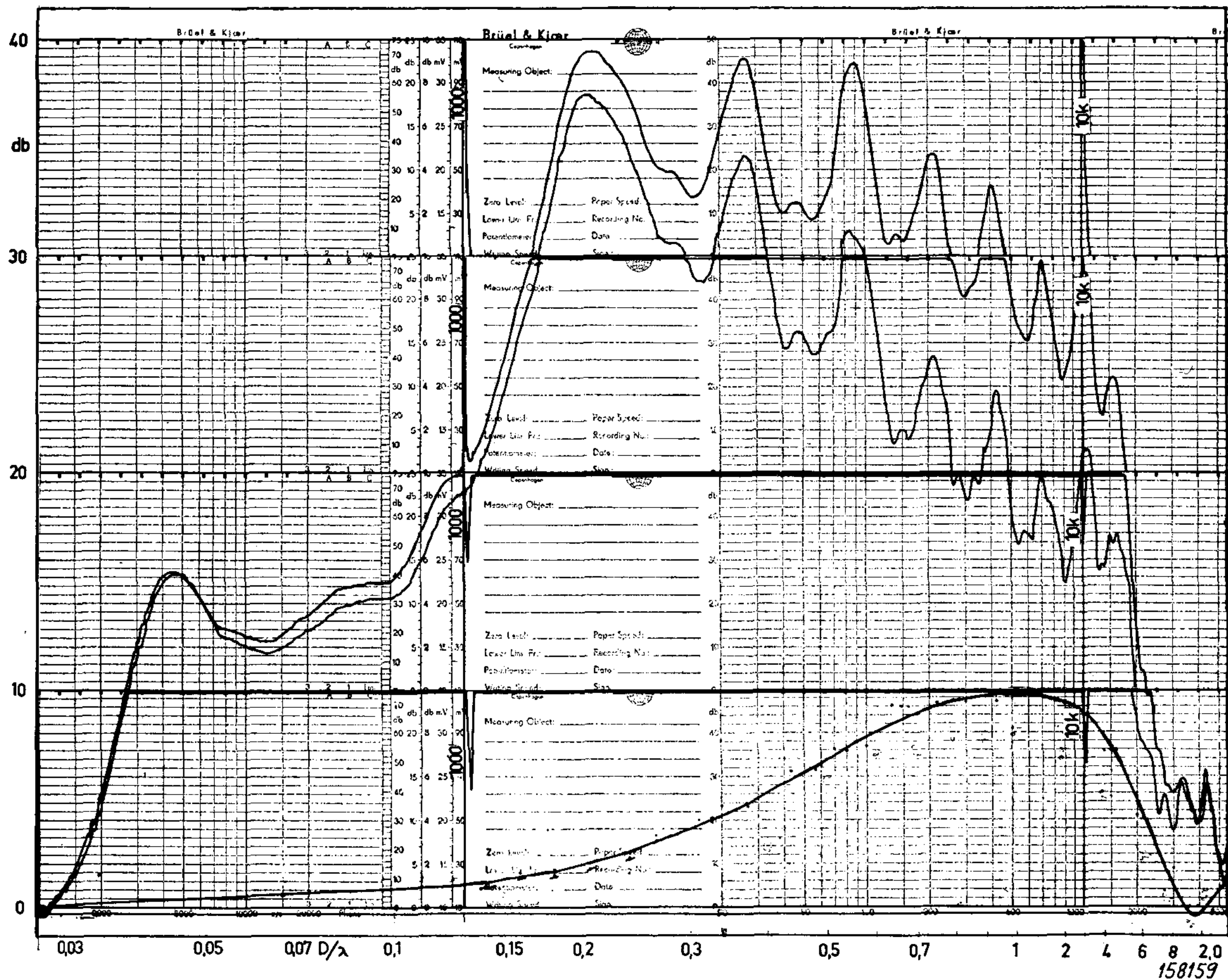

Fig. 5. Frequency response curves for loudspeaker + probe tube microphone with and without the cylinder measured with high resolution.

distribution across the diaphragm the measuring arrangement shown in Fig. 6 has been used, where a wire coupled to the paper spindle of the Level Recorder moves a cylinder perpendicularly to the sound field immediately behind the probe tube microphone. As the pressure increase is highly dependent on frequency a complete distribution curve must be recorded for each frequency.

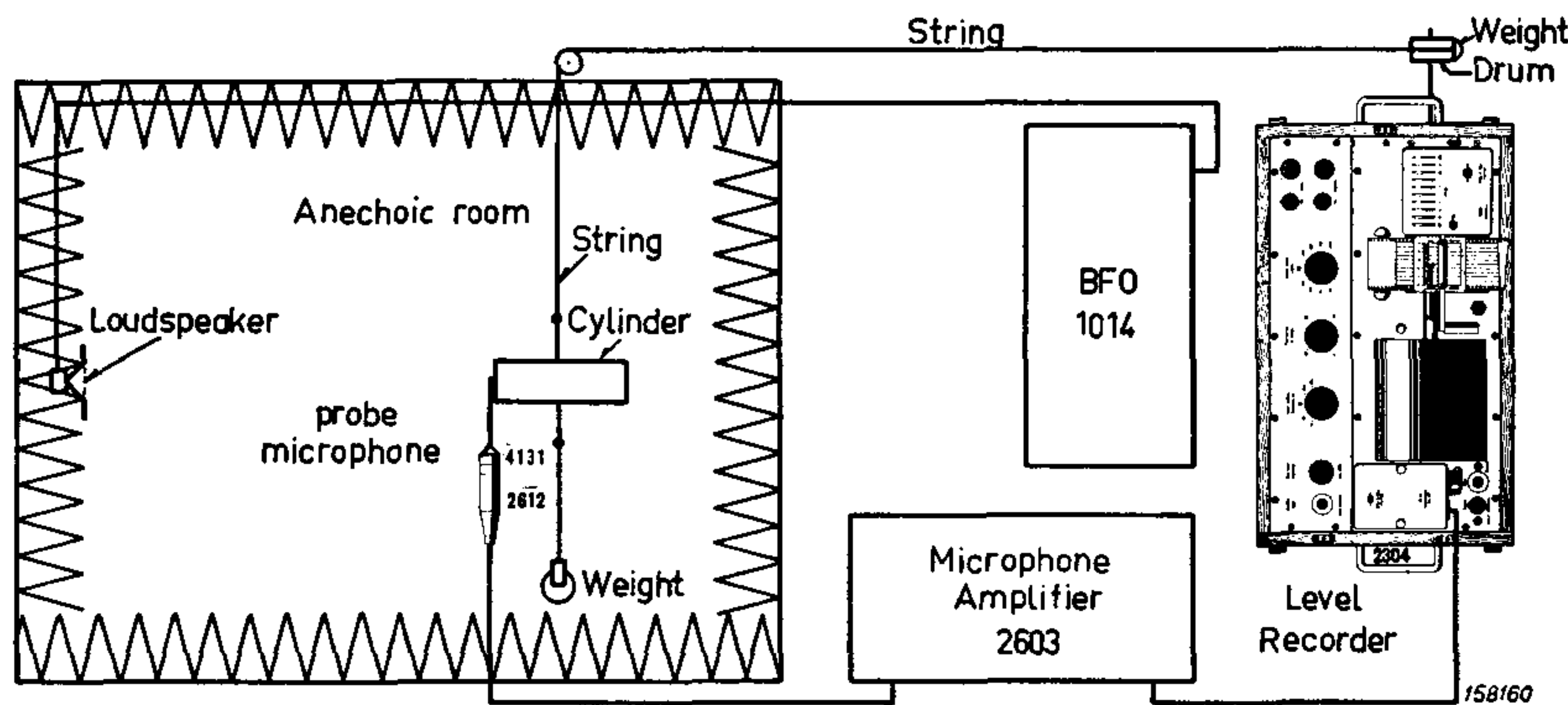

Fig. 6. Automatic recording of the pressure distribution across a cylinder.

News from the Factory

Pick-up MP 0001.

The Pick-up MP 0001 is designed to be used in connection with the Roughness Meter Type 6100. MP 0001 is similar to the Pick-up MP 6100 normally delivered together with the Roughness Meter Type 6100, but features:

Tip Radius of Pick-up: ca. 2.5 μ metres (100 μ inches).

Stylus Pressure: Smaller than 0.5 grammes.

Mechanical Resonance: as for MP 6100.

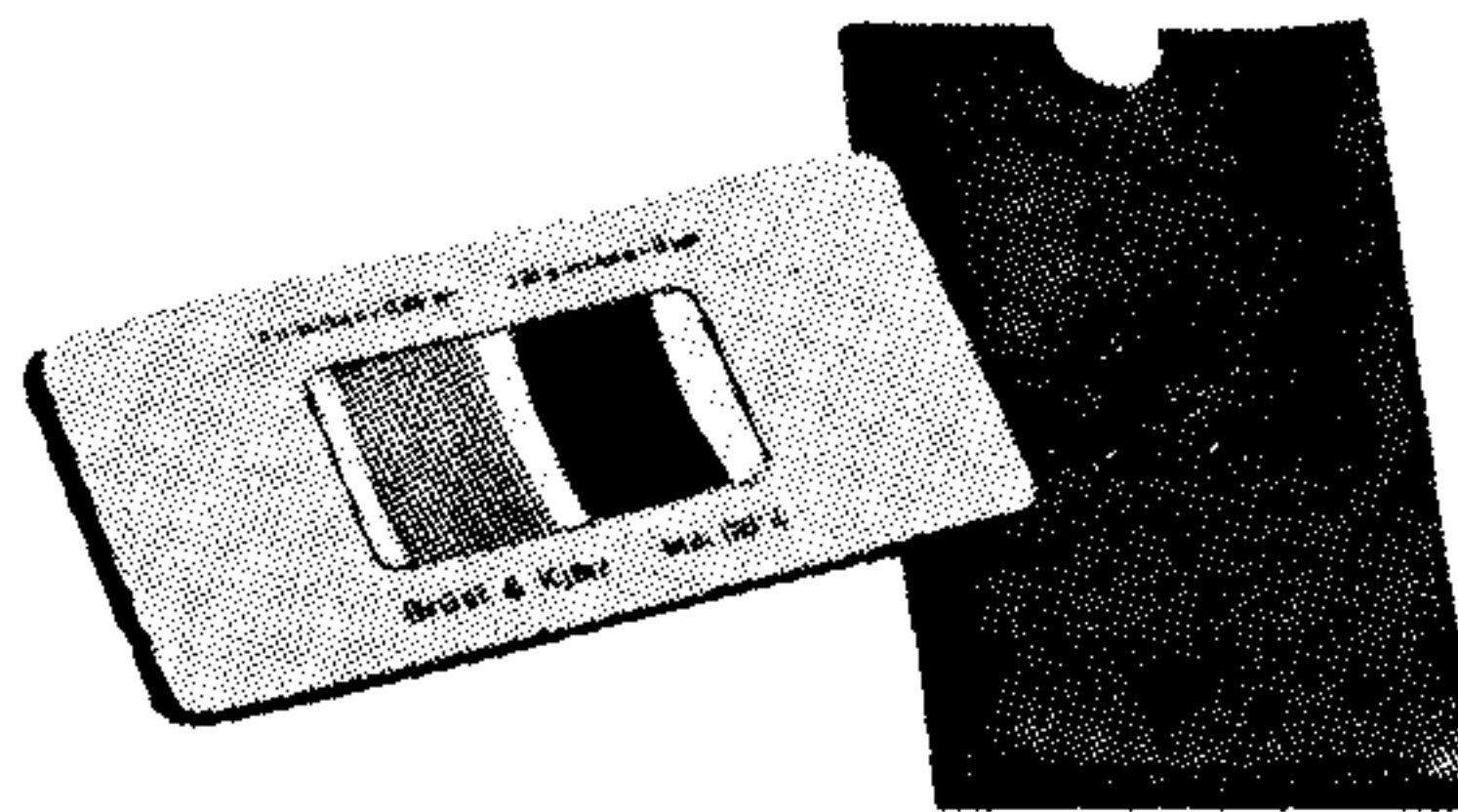

Fig. 1. Photo of the Reference Specimens MA 0001.

MP 0001 is intended to be used for measurements on very smooth surfaces (small roughness values). Due to the small tip radius, the Pick-up follows the surface under test very closely, which by normal (3 mm/sec.) trace speed tends to increase the amount of higher frequencies in the signal from the Pick-up. To counteract this phenomenon, the traversing speed should be decreased to approx. 0.6 mm/sec. This is the traversing speed of the slower moving arm of the Motor Drive Type 3910.

When calibrating the MP 0001 + Type 6100, the 3 mm/sec. speed of the Motor Drive Type 3910 should be used on the coarser of the two surfaces of the Reference Specimens MA 0014.

Reference Specimens MA 0014.

The Reference Specimens MA 0014 are less expensive reference surfaces than the Precision Reference Specimens MA 0011. MA 0014 consists of two surfaces of different roughness values:

A fine surface with a roughness value of $0.46 \mu\text{metres}$
($18 \mu\text{inches}$) CLA, and
a coarse surface with a roughness value of $6 \mu\text{metres}$
($230 \mu\text{inches}$) CLA.

The instrument reading of the Roughness Meter Type 6100 should be $230 \mu\text{inches}$ when the coarse surface is measured by means of both Pick-ups (MP 6100 and MP 0001), and approx. $10 \mu\text{inches}$ when the fine surface is measured by means of MP 6100 and $15\text{--}18 \mu\text{inches}$ when measured by MP 0001.

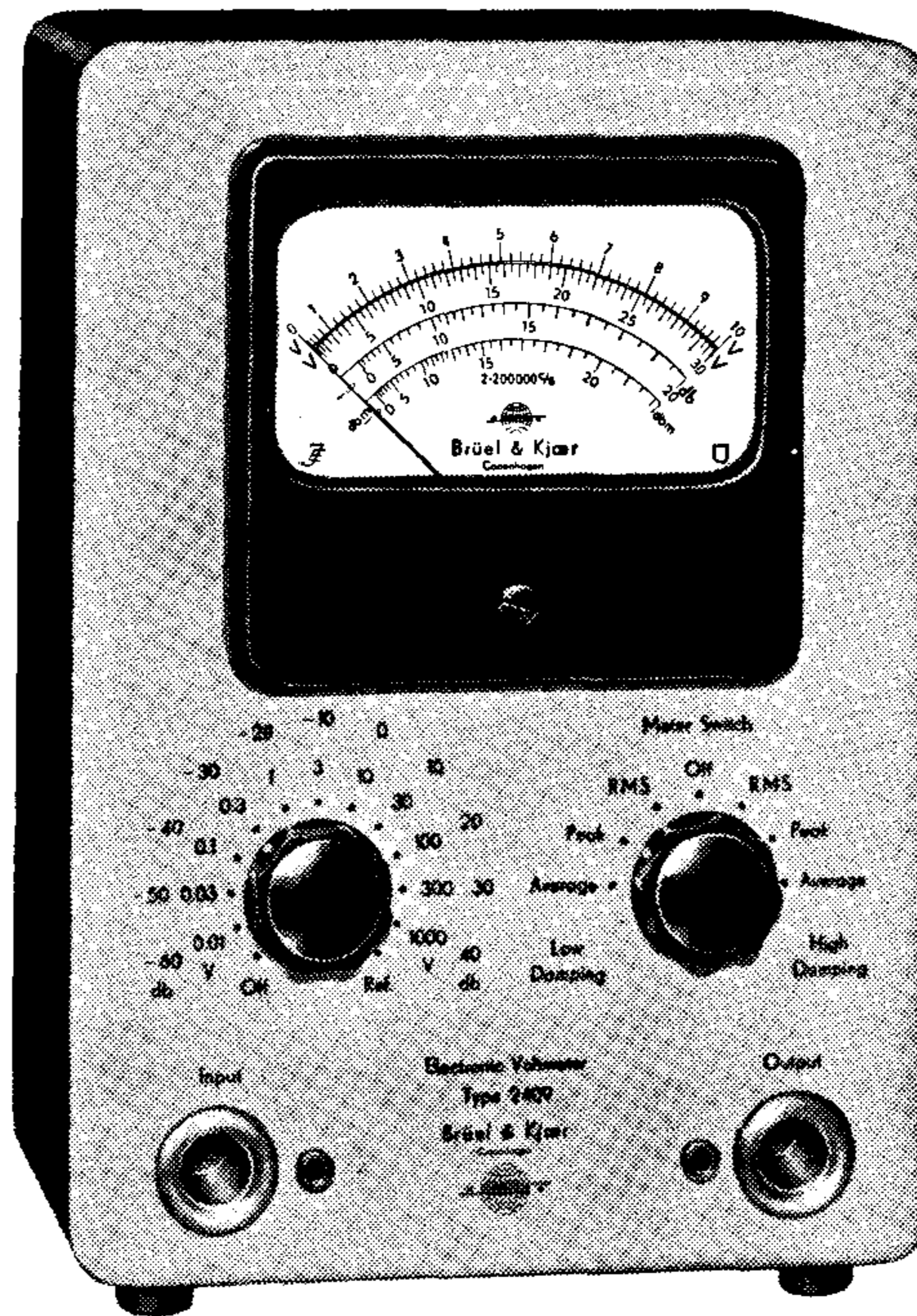

Fig. 2. Photo of the Electronic Voltmeter Type 2409.

Electronic Voltmeter Type 2409.

The Electronic Voltmeter Type 2409 is designed for AC voltage measurements in the frequency range 2 c/s to 200000 c/s with sensitivity for full scale deflection variable in 10 db steps from 10 mV to 1000 volts. It consists of an amplifier and a moving coil meter with rectifying circuits for RMS, average, and peak indication. Furthermore, the instrument is designed with two different meter dampings, one VU damping and a higher damping to be used for measurements of low frequency signals. The Voltmeter is equipped with an output bushing which makes it possible to use the instrument as a calibrated amplifier with a max. gain of 60 db

New Microphone Equipment.

Condenser Microphone Cartridge Type 4132 is a new design which fulfills the requirements of the American Standard ASA ZS 24.8.-1949 to laboratory

standard pressure microphones type L. Around this Microphone a complete equipment is developed. In the following the different instruments are listed.



Fig. 3. Photo of the Microphone Cartridge Type 4132.

Microphone Cartridge Type 4131.

Should be used in connection with Cathode Follower Type 2612 or 2613.

Frequency Response: Flat free-field response from 20 c/s to approx. 18000 c/s. Individually calibrated from 20 to 20000 c/s. (Free-field conditions, perpendicular incidence, and pressure response).

Sensitivity: Individually calibrated. Approx. 3.5—5.5 mV/ μ bar (—49 db to —45 db re 1 V/ μ bar) measured as output voltage from Cathode Follower Type 2612 or 2613.

Dynamic Range: Approx. 15 db to 146 db re 2×10^{-4} μ bar (Weighted).

Temperature Range: The sensitivity of the Cartridge + Cathode Follower Type 2612 or 2613 is nearly independent of temperatures to above 100° C.

Cartridge Capacity: Individually measured. Approx. 60 $\mu\mu$ F when polarized.

Polarization Voltage: 200 volts.

Equivalent Volume: Less than 0.2 cm³.

Construction: The Microphone Cartridge is cylindrically shaped, the outer diameter being 23.77 mm (0.936") and the height 19 mm (0.75") including the protecting grid. When the grid is removed the front surface of the microphone is acoustically plane. Diaphragm and housing material: Nickel and nickel alloy. Insulator: Silicone treated quartz.

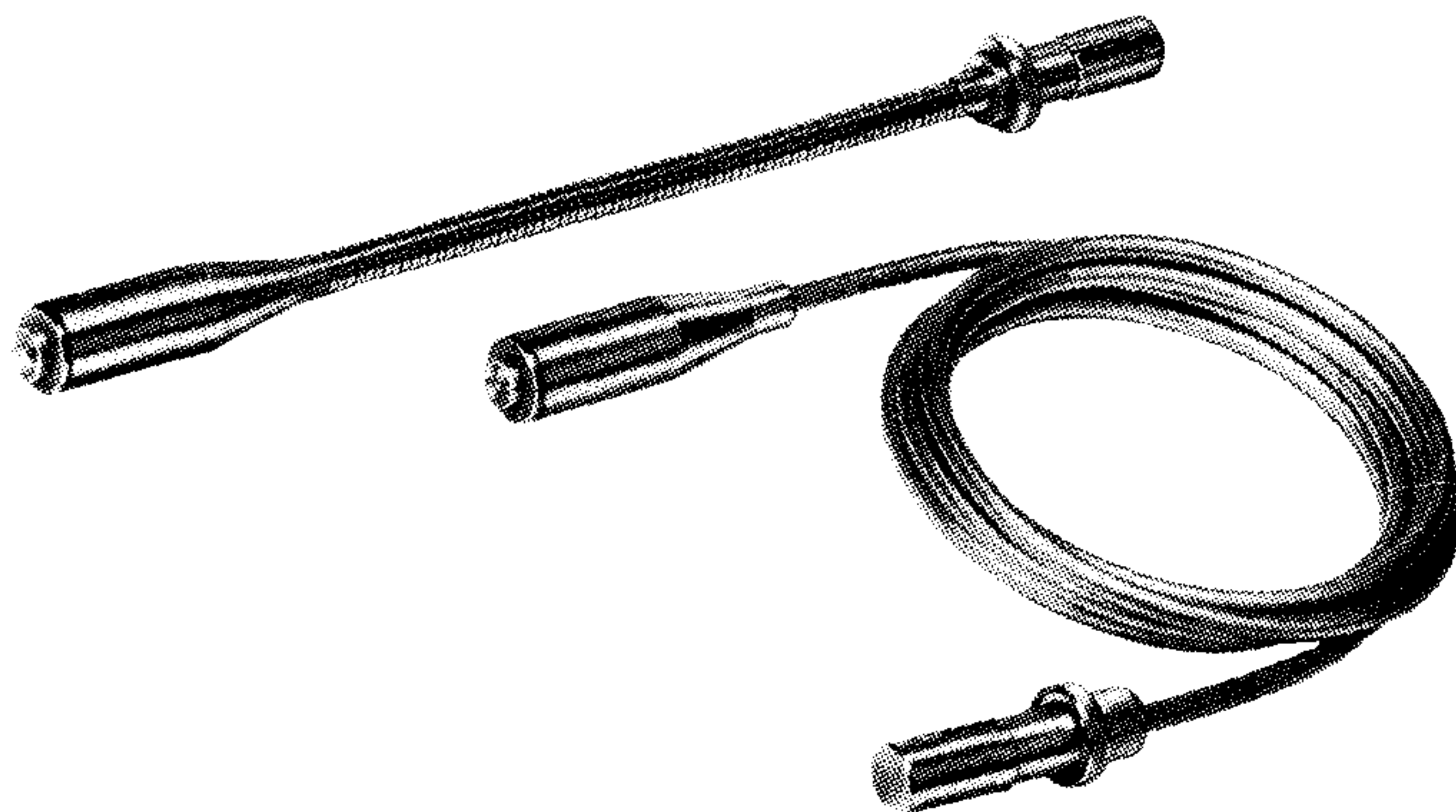

Fig. 4. Photo of the Cathode Followers Type 2612 and 2613.

Microphone Cartridge Type 4132.

similar to type 4131 except for:

Frequency Response: Flat pressure response within 2 db from 20 to 7000 c/s. Equivalent volume individually measured.

Cathode Follower Type 2612 and Type 2613.

The Cathode Followers Type 2612 and 2613 are designed for connection to the B & K Condenser Microphone Cartridges or Accelerometers, **transforming the high source impedance of the transducer to the relatively low output impedance of the Cathode Follower**, with a minimum loss in sensitivity and frequency response.

The two types of Cathode Followers are electrically identical units. Concerning the mechanical construction, however, the Cathode Follower Type 2612



Fig. 5. Photo of the Microphone Calibration Apparatus Type 4141.

is built on a flexible gooseneck terminating in a 7-pin plug, while Type 2613 is supplied with a 2 m long 7-conductor cable.

Input Impedance: Approx. $270\text{ M}\Omega$ in parallel with $3\ \mu\mu\text{F}$.

Output Impedance: Approx. $1500\ \Omega$

Transmission Loss: Approx. 1 db.

Self-generated Noise Level: Lower than $30\ \mu\text{V}$ (input loaded with a capacitor of $60\ \mu\mu\text{F}$).

Tube: EF 731 (5899).

Microphone Calibration Apparatus Type 4141.

The construction and use of this instrument is similar to its predecessor Type 4119, with different improvements.

Artificial Ear Type 4151.

The Artificial Ear Type 4151 is a completely new design. It consists basically of a replaceable acoustical coupler, a socket for mounting a Condenser Microphone Cartridge Type 4132 and a Cathode Follower Type 2613, and a spring arrangement to supply the force required in ASA Standard Z 24.9.-1949 for earphones under test. The Microphone Cartridge and the Cathode Follower are not included in Type 4151.

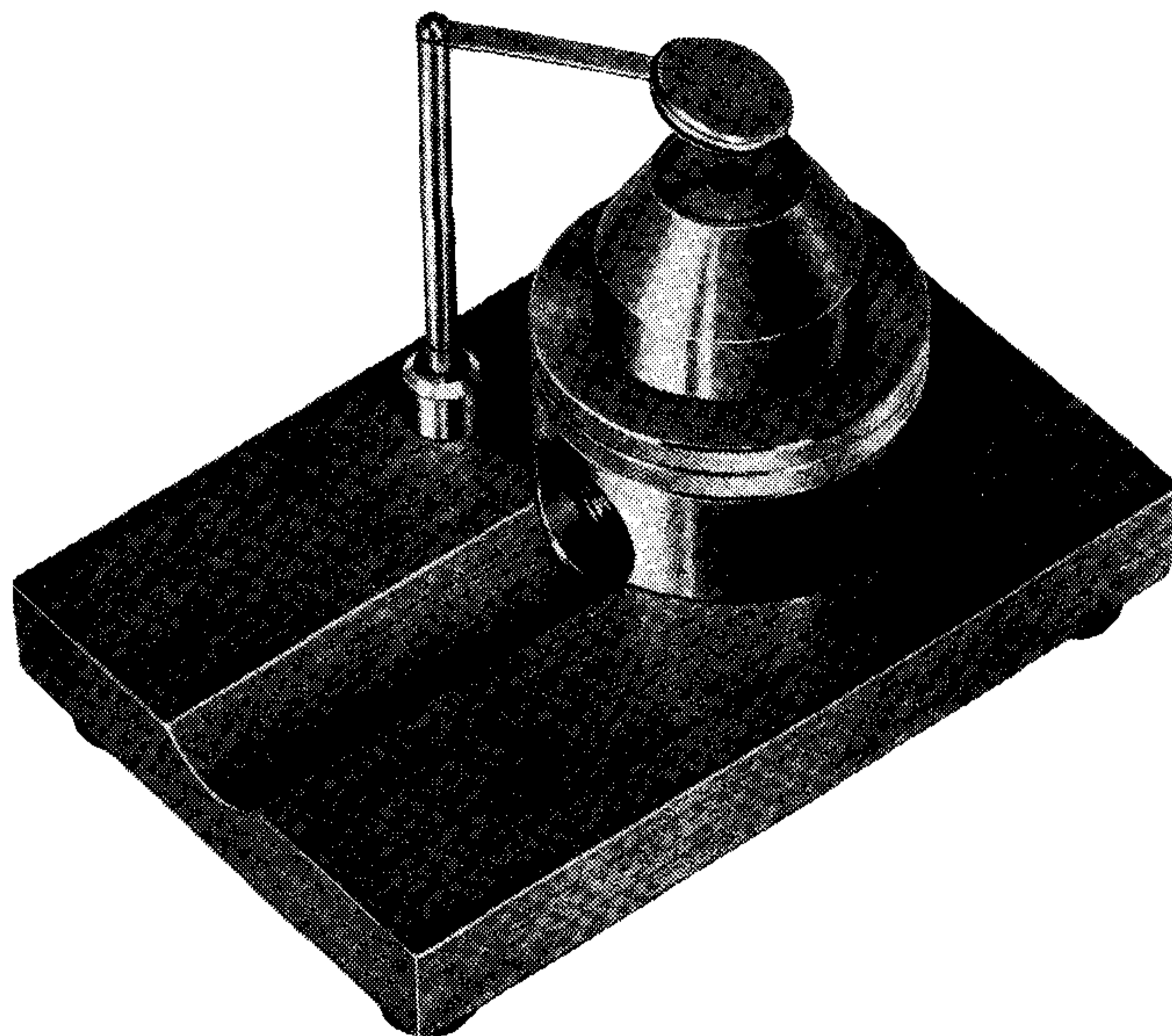

Fig. 6. Photo of the Artificial Ear Type 4151.

The acoustic coupler (DB 0138) included in the Artificial Ear Type 4151 is a 2 cc coupler for measurements on insert types of earphones such as the ones normally used in hearing aids. It meets the specifications laid down in the American Standard ASA Z 24.9.-1949 as well as the new international IEC standard for couplers drawn up in Stockholm 1958. The 2-cc coupler may be screwed off the Artificial Ear and used separately in connection with the Condenser Microphone. The 2-cc coupler is designed to catch a standard earphone and seal it without the use of extra arrangements.

As required in the IEC standard, facilities are provided for replacing the 2-cc coupler with a 6-cc coupler DB 0160 (NBS Type A) or DB 0161 (ASA Z 24.9.-1949, Type 1). The 6-cc couplers must be ordered separately as DB 0160 resp. DB 0161.

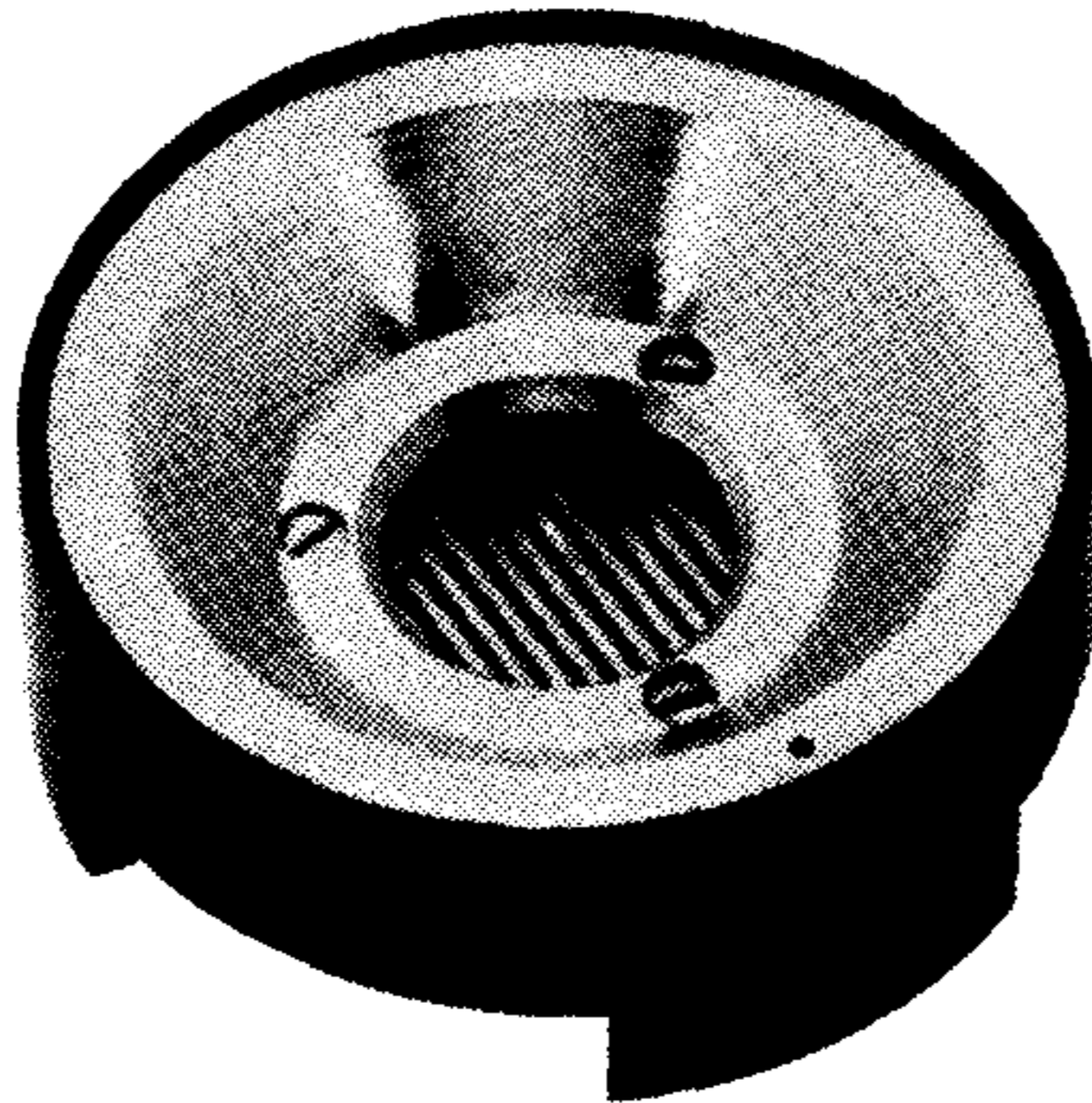

Fig. 7. Photo of the Electrostatic Actuator UA 0023.

Electrostatic Actuator UA 0023.

The Electrostatic Actuator is designed for checking the Microphone Cartridges Type 4131 and 4132. It is a redesign of the Electrostatic Actuator Type 4113. UA 0023 is designed so that the electrostatic force on the Microphone diaphragm is independent of the microphone, whereby it is possible to adjust the Actuator to supply a force corresponding to the force from a sound pressure of $10 \mu\text{bar}$, when used with a DC Voltage of 800 volts and an AC voltage of 30 volts R.M.S. The adjustment is carried out by the factory.

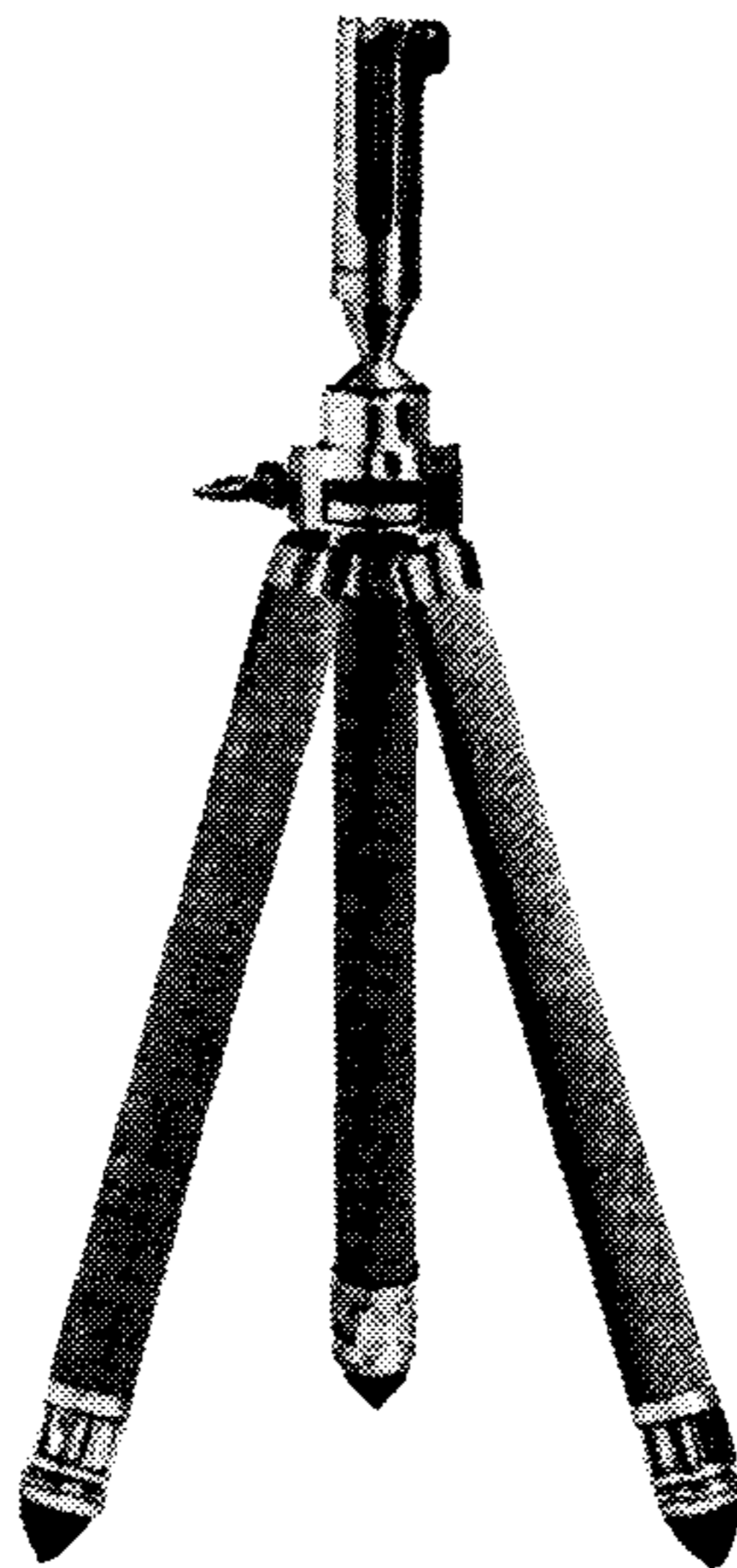

Fig. 8. Photo of the Microphone Stand UA 0026.

Microphone Stand UA 0026

is a light-weight, portable tripod similar to those used in amateur camera work. The height of the Stand can be adjusted from approx. 30 cm to

approx. 110 cm and the Microphone is mounted by means of the Tripod Adaptor UA 0028 (included in UA 0026).

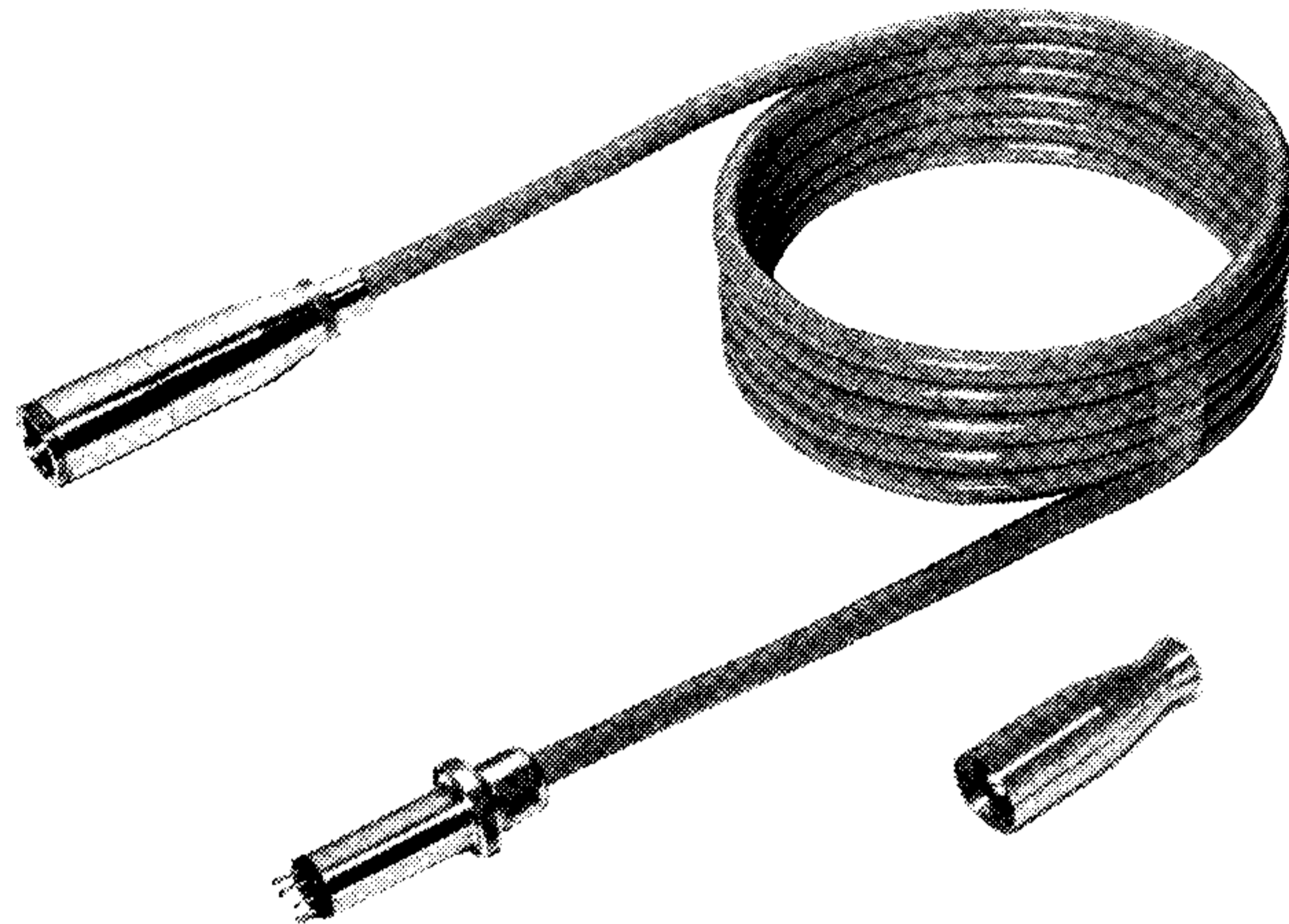
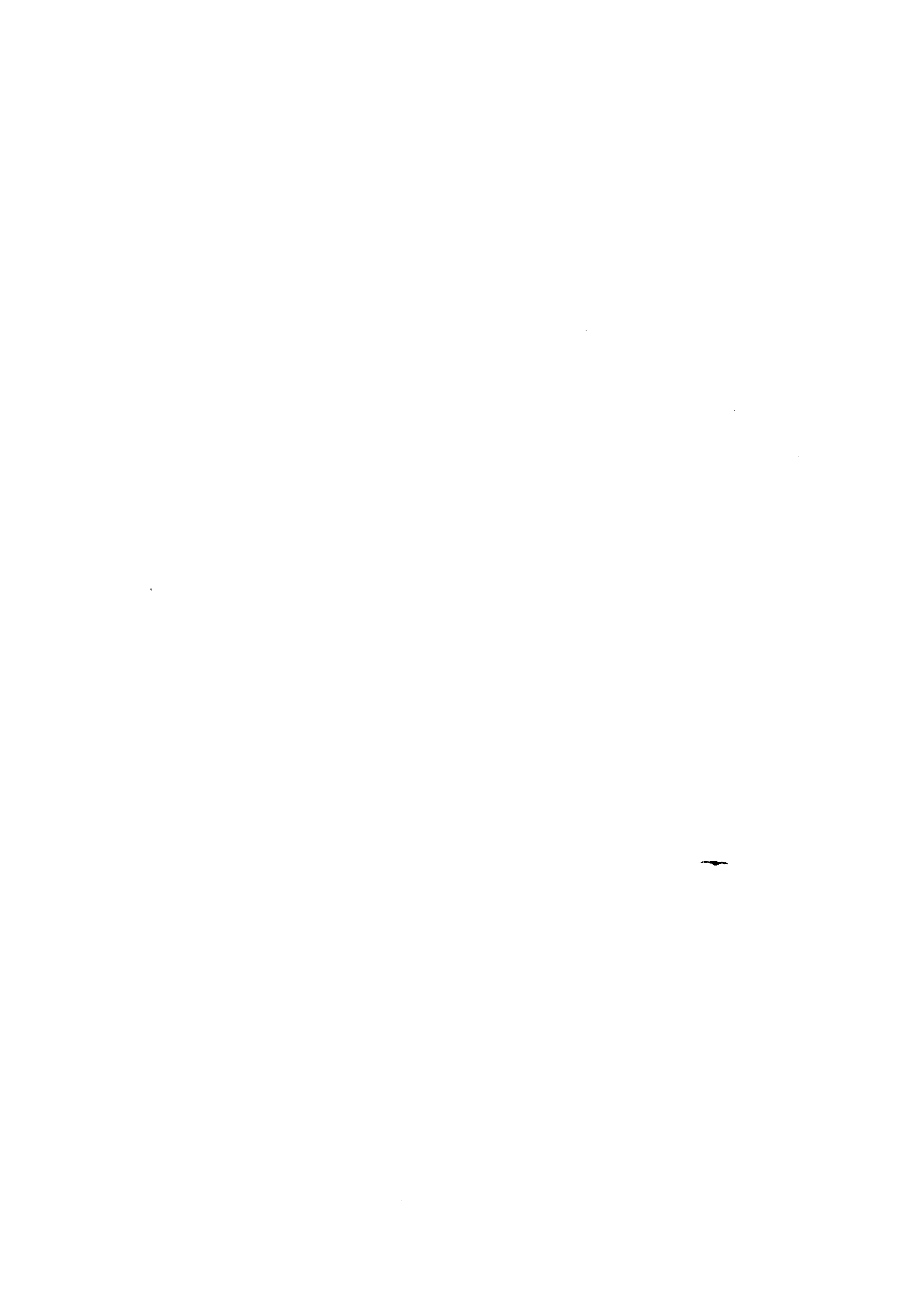

Fig. 9. Photo of the Microphone Cable AO 0027 and of the Cathode Follower Adaptor JJ 2612.

Microphone Cable OA 0027 is a 3 m long 7-conductor shielded cable supplied with B & K Microphone Connectors in both ends. Outside diameter 6 mm. Capacity to ground of signal transmission conductor 100 pF/m ($33 \mu\mu\text{F}/\text{foot}$). **Cathode Follower Adaptor JJ 2612** is a two poled coaxial screened socket to be mounted on the Cathode Followers Type 2612 and Type 2613 for connection to the Plugs JP 0014. JJ 2612 contains a capacitor of approx. $6000 \mu\mu\text{F}$.

Bibliography:

1. Ballantine, S.: *Journal of Acoust. Soc., Amer.* Vol. 3, p. 319 (1932)
2. Brüel & Kjær: *Instruction Manual 4119*, p. 23 (1947).
3. American Standards Association: Z 24.4-1949.
4. Kjerbye-Nielsen, A.: *Acustica* Vol. 2, p. 112 (1952).
5. Kjerbye-Nielsen, A.: *Measurements of Microphones* (in Danish) with English Summary — Copenhagen 1949
6. Brüel & Kjær: *Instruction Manual 4119*, p. 5 (1957).
7. Glover & Baumzweiger: *Journ. Acoust. Soc. Amer.* Vol. 10, p. 200 (1939).
8. Willem Brand: Brüel & Kjær, *Technical Review* No. 3, p. 6, July 1955.
9. Sivian and ONiel: *Diffraction by Rigid Circular Plate, Square Plate, and Semi-infinite Screen.* J.A.S.A. Vol. 3, p. 483 (1932).
10. Müller, Black, and Davis: *Diffraction produced by Obstacles and Plates.* J.A.S.A. Vol. 10, p. 6 (1938).
11. Kjerbye-Nielsen, A.: *Measurements of Microphones* — loc. at p. 107.
12. Rivin, A. A.: At the 4th All-Union Acoustic Conference in Moscow 1958. Mr. A. A. Rivin has given a paper on the determination of the pressure increase on Condenser Microphones using comparison of free-field and pressure reciprocity methods. Mr. Rivin's results confirm by and large the results given in Fig. 10. Mr. Rivin's paper is not yet published.
13. Rucnick, J. and Stein, M. N.: *Reciprocity Free-field Calibration of Microphones to 100 kc in Air.* J.A.S.A. Vol. 20, No. 6, p. 818.



Brüel & Kjær

ADR.: BRÜEL & KJÆR
NÆRUM - DENMARK



TELEX 5316

TELEPHONE: 80 05 00
⚡ BRUKJA, Copenhagen

Printed in Copenhagen, Denmark